

Installation Systems Catalogue

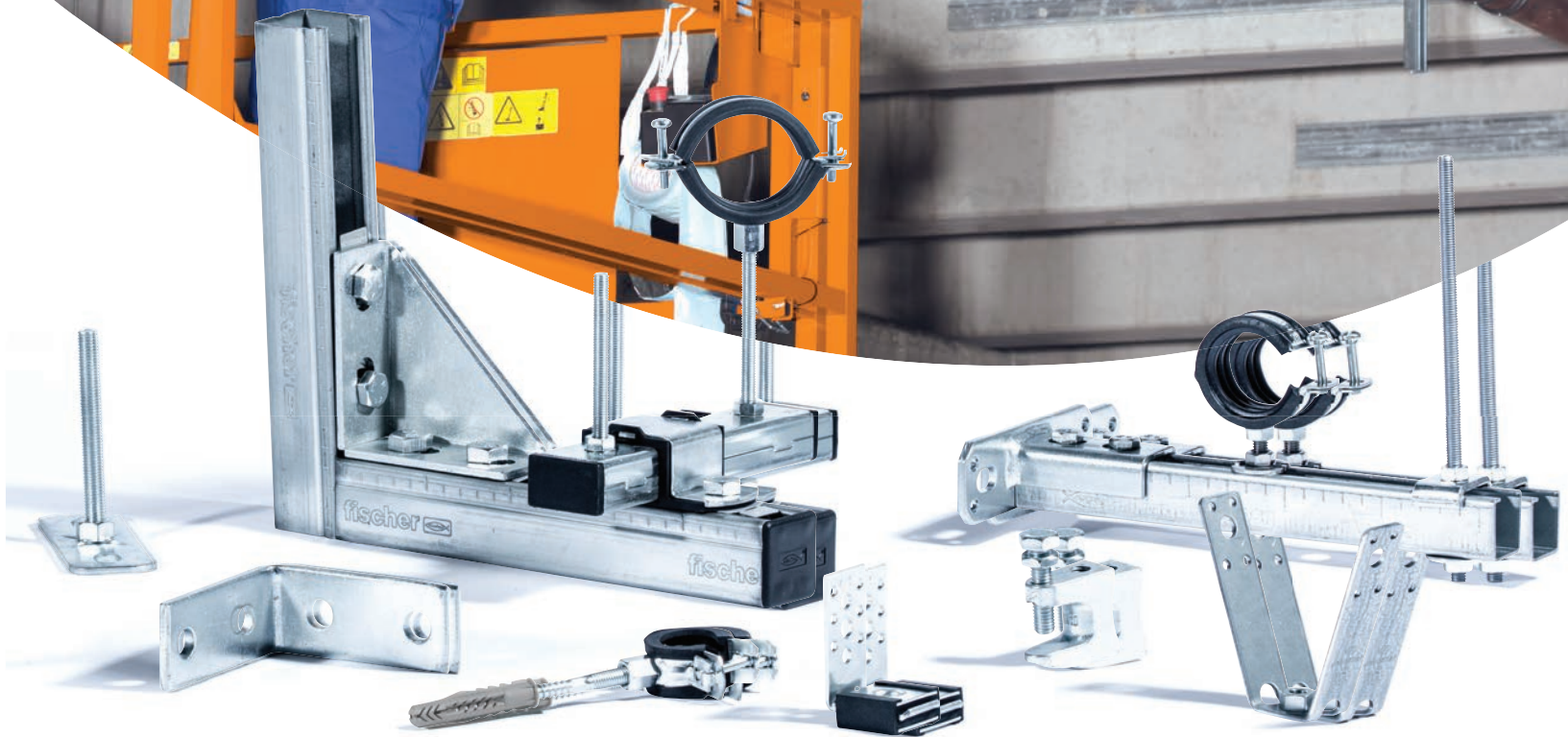

A BRAND AND ITS PROMISE
TO PERFORM



Prof. Klaus Fischer

Dear Partners,

The increasing diversity of building materials, the constantly changing combination principles of different materials and the ever-increasing requirements with regard to processing all demand constant development of our fixing systems. Our goal, therefore, is, and will always be, to provide you with the best technical solution for your current fixing job quickly and with as much flexibility as possible.

Our innovative strength has helped us to become a globally recognised and esteemed specialist when it comes to secure and economical fixings at building sites. Our products range from chemical systems to steel anchors through to plastic fixings. Innovative façade systems, a comprehensive range of screws, special product ranges for thermal insulation composite systems, sanitary, heating, ventilation and electrical installations, adhesives, sealants and foams. We have the ideal solution for every fixing problem and we always rely on the highest possible quality, maximum safety and ease of installation.

Sustainability has been a key part of our work for decades now. Our active environmental management policy means that we are helping to maintain an intact environment for our generation and for those that follow. We fulfil this requirement not just in the way that we deal with energy, raw materials and auxiliary materials on a day-to-day basis but also in the development of new products. As a concrete result and consequence of this fundamental strategy, in spring 2014 we became the first manufacturer in the world to offer fixings made from predominantly renewable raw materials. This new "greenline" range features a number of different plastic fixings and a two-component injection mortar for heavy loads. All "green" fischer products have the same performance properties as their grey-coloured counterparts. Applications have been submitted for ETA approvals (masonry and option 7 for concrete) for the injection mortar. With this innovative and forward-looking range of products, we are addressing processors and builders who greatly value sustainability when building and renovating, and especially when it comes to installation.

We are close to our customers across the world – with 44 subsidiaries around the globe and sales partners in over 100 countries. We develop and produce our products ourselves – and we can even develop and produce customer-specific solutions if required. We place great value on both outstanding and innovative products and on providing a wide range of services of excellent quality: Qualified technical support staff advise you on an individual basis and on location. Our hotline puts you into direct contact with the fischer technical support team, who are able to provide fast and professional assistance for all fixing jobs. Finally, we also provide design programs and technical handbooks, which we have developed in-house. And, last but not least, the fischer ACADEMY, situated at our headquarters in Tumlingen, provides the ideal conditions for getting to know our products and their many uses in practical training sessions. However, modern training courses in fixing technology are not just available at our company headquarters – fischer trainers can also be found around the globe.

We hope that you enjoy using our fixing systems.



Klaus Fischer

Hinged pipe clamp FGRS.....	06
Pipe clamp FRS.....	07
Pipe clamps FRSR	08
Silicon pipe clamp FRSH.....	09
Pipe clamps FRSR-N.....	10
Pipe clamps FRSN.....	11
Heavy duty pipe clamp FRSM M10 / M12 / M16.....	12
Sprinkler clamp FRSP C.....	13
Clevis hanger FCH.....	14
Riser Clamp RCWR.....	15
Rubber Support Insert FRSI.....	16
U-Bolt ETR.....	17
U-Strap USP.....	18
Fixpoint Clamp FFPS and saddle FFPK.....	19
Sliding element GL / FSC1 / SBS.....	20
Sliding hanger SB / Pendulum hanger PDH / PDH K.....	21
Ventilation duct clamp LGS.....	22
Textile web strapping GWB / Perforated steel banding LBV / LBK.....	23
Channel MS.....	24
Cantilever arm.....	25
Saddle flange SF.....	26
Installation angle bracket MW.....	26
Channel connector SV.....	27
Channel connector FUF OC and PFUF OC.....	27
Channel washer HK.....	28
Channel nut HG, SM.....	28
Channel FUS.....	29
Cantilever arm FCA.....	30
Saddle flange SF L.....	31
Angle fittings FAF.....	31
FUS 3D flanges FZF, FUF.....	32
Flat fittings FFF.....	32
Variable bracket VB / Bracket FSB 45°.....	33
Beam Clamp Steel TKLS Steel Bite.....	34
Channel washer HK 41.....	34
Channel nut FCN Clix.....	35
Beam clamp TKR.....	36
Clamp hanger TKL.....	36
Construction element - Bracket WK / UW S.....	37
Channel base.....	38
Cover cap FEC.....	38
Threaded rod G / Threaded stud GS.....	39
Threaded rod TRS.....	40
Threaded rod TRSL.....	40
Hexagonal Bolt SKS.....	41
Hexagonal screw SKSL.....	41
High strength threaded stud TSL.....	42

Reduction socket RDM and GRD.....	42
Hexagonal nut MU.....	43
Hexagonal nut HN.....	43
Washer U.....	44
Washer MW.....	44
Hexagonal connector VM.....	45
Reduction piece RD.....	45
Push-through connector PFCN.....	46
Push-through saddle flange PSF.....	47
Push-through bracket.....	47
Push-through bracket PFAF / PFUF.....	48
Push-through brackets PFUF D.....	48
Push-through variable bracket PVB.....	49
Push-through bracing elements PSAE.....	49
Channel FLS.....	50
Cantilever arm ALK.....	50
Angle brace WS 31-45°.....	51
Channel connector SV 31.....	51
Sliding channel nut FSM Clix P.....	52
Channel washer HK 31.....	52
Anti-corrosion spray.....	53
Annexure.....	54
Worldwide Presence.....	68

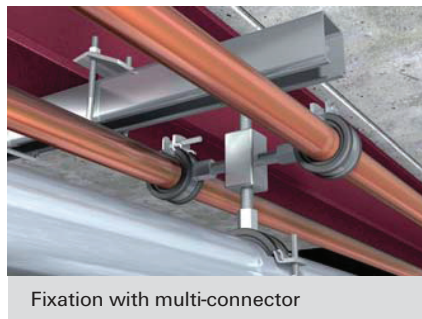

PROPERTIES

- **Material:** Steel DD11 (material no. 1.0332 acc. to DIN EN 10111/ASTM A569)
- **Zinc plating:** Electro zinc plated 5 - 9 µm
- **Standard:** comply with ASTM B633 SC1
Also available in SC3 on special request.
- **Connecting nut:** resistance welded, M8, SW 13
- **Locking screw:** flat head screw with combination recessed head
- **Material sound insulation insert:** EPDM; chlorine-free; silicone-free
- **Sound insulation:** for DIN 4109
- **Temperature range:** -40 °C to +100 °C
- **Hardness:** 45 ± 5° Shore A
- **Fire behaviour:** DIN 4102: Class B2

ADVANTAGES/BENEFITS

- The floating single screw allows for simple, one-handed installation
- The safety latch fastening guarantees secure pipe installation without the clamp springing open.
- The compact construction of the pipe clamp allows for simple post-installation insulation.
- The screw's design stops it falling out during installation

INSTALLATION

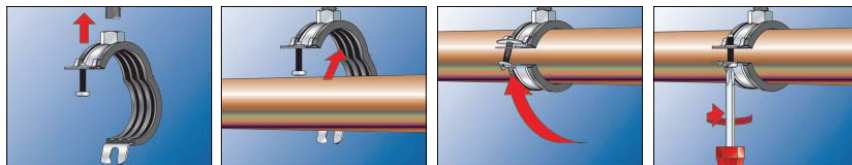

TECHNICAL DATA

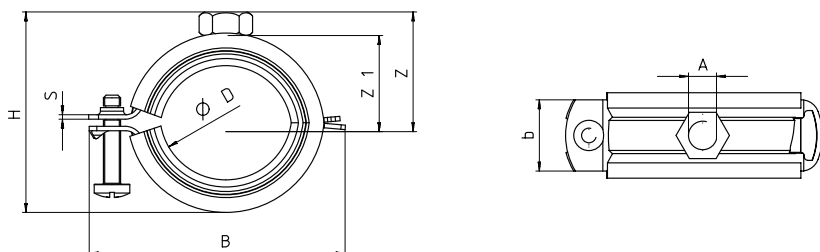

Item	Art.-NO.	Thread A	Size (inch)	Clamping range D (mm)	Width B B (mm)	Height H H (mm)	b x s (mm)	Height Z Z (mm)	Locking Screw	Recommended load N _{rec} (kN)	Design load N _d (kN)	Sales unit (pcs)
FGRS 12 - 14	079420	M 8	1/4"	12 - 14	48	31	20 x 1.25	21	M 5	0.80	1.12	100
FGRS 15 - 19	079421	M 8	3/8"	15 - 19	52	36	20 x 1.25	14	M 5	0.80	1.12	100
FGRS 20 - 24	079422	M 8	1/2"	20 - 24	58	41	20 x 1.25	26	M 5	0.80	1.12	100
FGRS 25 - 30	079423	M 8	3/4"	25 - 30	63	47	20 x 1.25	28	M 5	0.80	1.12	100
FGRS 32 - 37	079424	M 8	1"	32 - 37	72	54	20 x 1.25	32	M 5	0.80	1.12	100
FGRS 40 - 44	079425	M 8	1 1/4"	40 - 44	79	61	20 x 1.5	37	M 5	0.90	1.26	50
FGRS 45 - 50	079426	M 8	1 1/2"	45 - 50	88	67	20 x 1.5	42	M 5	0.90	1.26	50
FGRS 50 - 55	079427	M 8	-	50 - 55	94	72	20 x 1.5	45	M 5	0.90	1.26	50
FGRS 56 - 63	079428	M 8	2"	56 - 63	99	80	20 x 1.5	46	M 5	0.90	1.26	50



ADVANTAGES/BENEFITS

- The fire test report guarantees independantly tested functional safety
- The combination nut with thread M8/M10 allows for optimised mounting choices
- The sound insulation insert offers noise protection and prevents contact corrosion

INSTALLATION

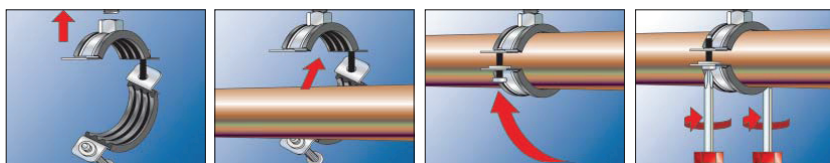

TECHNICAL DATA

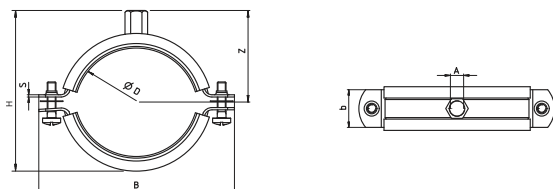

Item	Art.-NO.	Thread A	Size (inch)	Clamping range D (mm)	Width B B (mm)	Height H H (mm)	b x s (mm)	height Z Z (mm)	Locking Screw	Recommended load N _{rec} (kN)	Design load N _d (kN)	Sales unit (pcs)
FRS 12 - 15 M8/M10	510969	M 8/M 10	1/4"	12 - 15	55	39	20 x 1.25	31	M 6	1.00	1.40	100
FRS 15 - 19 M8/M10	042535	M 8/M 10	3/8"	15 - 19	59	43	20 x 1.25	29	M 6	1.00	1.40	100
FRS 20 - 24 M8/M10	042536	M 8/M 10	1/2"	20 - 24	65	48	20 x 1.25	32	M 6	1.00	1.40	100
FRS 25 - 30 M8/M10	042537	M 8/M 10	3/4"	25 - 30	72	54	20 x 1.25	35	M 6	1.00	1.40	100
FRS 32 - 37 M8/M10	042538	M 8/M 10	1"	32 - 37	77	61	20 x 1.25	38	M 6	1.00	1.40	100
FRS 40 - 45 M8/M10	042554	M 8/M 10	1 1/4"	40 - 45	89	69	20 x 1.25	42	M 6	1.00	1.40	50
FRS 48 - 54 M8/M10	510970	M 8/M 10	1 1/2"	48 - 54	99	78	20 x 1.25	46	M 6	1.00	1.40	50
FRS 55 - 61 M8/M10	042555	M 8/M 10	2"	55 - 61	105	85	20 x 1.25	50	M 6	1.00	1.40	50
FRS 63 - 67 M8/M10	091488	M 8/M 10	-	63 - 67	11	91	20 x 1.25	53	M 6	1.00	1.40	50
FRS 72 - 80 M8/M10	091489	M 8/M 10	2 1/2"	72 - 80	125	104	20 x 2.0	60	M 6	1.50	2.10	25
FRS 87 - 92 M8/M10	091505	M 8/M 10	3"	87 - 92	137	116	20 x 2.0	66	M 6	1.50	2.10	25
FRS 108 - 116 M8/M10	091506	M 8/M 10	4"	108 - 116	164	140	25 x 2.0	78	M 6	2.0	2.80	20
FRS 121 - 128 M8/M10	079456	M 8/M 10	-	121 - 128	176	152	25 x 2.5	84	M 6	2.50	3.50	10
FRS 133 - 141 M8/M10	079457	M 8/M 10	5"	133 - 141	187	165	25 x 2.5	90	M 6	2.50	3.50	10
FRS 159 - 165 M8/M10	079458	M 8/M 10	-	159 - 165	211	198	25 x 2.5	102	M 6	2.50	3.50	8
FRS 165 - 168 M8/M10	079459	M 8/M 10	6"	165 - 168	225	192	25 x 2.5	104	M 6	2.50	3.50	8
FRS 3/8" A4	064864	M 8	3/8"	15 - 19	62	40	20 x 1.2	23	M 6	1.00	1.40	100
FRS 1/2" A4	064865	M 8	1/2"	20 - 24	68	45	20 x 1.2	26	M 6	1.00	1.40	100
FRS 3/4" A4	064866	M 8	3/4"	25 - 30	75	52	20 x 1.2	29	M 6	1.00	1.40	100
FRS 1" A4	064868	M 8	1"	31 - 38	80	60	20 x 1.2	32	M 6	1.00	1.40	100
FRS 1 1/4" A4	064869	M 8	1 1/4"	40 - 46	90	67	20 x 1.2	37	M 6	1.00	1.40	50
FRS 1 1/2" A4	064870	M 8	1 1/2"	48 - 54	97	75	20 x 1.2	41	M 6	1.00	1.40	50
FRS 54 - 58 A4	064873 ⁽¹⁾	M 8	-	54 - 59	104	80	20 x 1.2	44	M 6	1.00	1.40	50
FRS 2" A40	064874	M 8	2"	60 - 64	110	85	20 x 1.2	46	M 6	1.00	1.40	50
FRS 67 - 71 A4	064875 ⁽¹⁾	M 8	-	67 - 71	119	92	25 x 1.2	49	M 6	1.00	1.40	25
FRS 2 1/2" A4	064879	M 10	2 1/2"	72 - 78	130	99	25 x 1.5	53	M 6	1.30	1.82	25
FRS 81 - 86 A4	064892 ⁽¹⁾	M 10	-	81 - 86	132	107	25 x 1.5	58	M 6	1.30	1.82	25
FRS 3" A4	064893 ⁽¹⁾	M 10	3"	87 - 92	144	113	25 x 1.5	60	M 6	1.30	1.82	25
FRS 95 - 103 A4	064894 ⁽¹⁾	M 10	-	95 - 103	156	124	25 x 1.5	66	M 6	1.30	1.82	25
FRS 4" A4	064898	M 10	4"	102 - 116	172	138	25 x 2.0	73	M 6	2.0	2.80	20
FRS 121 - 127 A4	064899 ⁽¹⁾	M 10	-	121 - 127	192	149	25 x 2.0	79	M 6	2.0	2.80	10
FRS 133 - 141 A4	064901 ⁽¹⁾	M 10	5"	133 - 141	198	163	25 x 2.0	86	M 6	2.0	2.80	10
FRS 159 - 168 A4	064903	M 10	6"	159 - 168	218	191	25 x 2.0	100	M 6	2.0	2.80	8

(1) Delivery time on request.

PROPERTIES

- **Material:** Steel DD11 (material no. 1.0332 acc. to DIN EN 10111/ASTM A569)
- **Zinc plating:** Electro zinc plated 5 - 9 µm
- **Standard:** comply with ASTM B633 SC1
Also available in SC3 on special request.
- **Material A4:** Stainless steel of the corrosion resistance class III, e.g. A4
- **Sound insulation insert:** Material-SBR/EPDM chlorine-free; silicone-free
- **Sound insulation:** According to DIN 4109
- **Temperature range:** -40 °C to +100 °C
- **Hardness:** 55 ± 5° Shore A
- **Fire behaviour:** DIN 4102: Class B2

APPROVALS



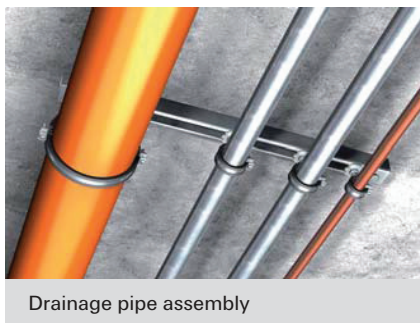

ADVANTAGES/BENEFITS

- Simple installation due to large opening angle.
- Locking screw secured against loss.
- Combination connecting thread for cost-effective warehousing and flexibility at the construction site.

INSTALLATION

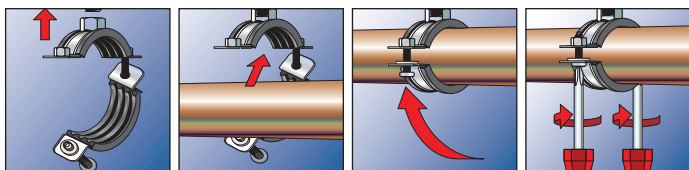

TECHNICAL DATA

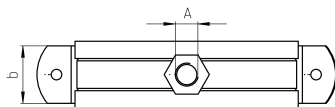
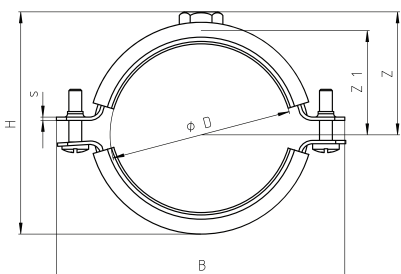

PROPERTIES

- **Material:** Steel
- **Zinc plating:** Electro zinc plated 5 - 9 µm
- **Standard:** comply with ASTM B633 SC1
- Also available in SC3 on special request.
- Also available in dacromet finish 8.6 µm
- **Connecting nut:** resistance welded, M8, SW 13
- **Locking screw:** flat head screw with combination recessed head
- **Sound Insulation inserts:**
Material EPDM: Chlorine-free; Silicon-free
- **Sound insulation:** acc. to DIN 4109
- **Temperature range:** -40 °C to +100 °C
- **Hardness:** 60 ± 5° Shore

Item	Galvanized Art.-NO.	Dacromet Art.-NO.	Qty. per box pcs.	Size (inch)	Clamping range D (mm)	s x b (mm)	Screw M	Thread diameter A (mm)	Recommended load N _{rec} (kN)	Design load N _d (kN)
FRSR 11-14 M8 / M10	534133	560283	100	1/4"	11-14	1.2 x 20	M5 x 16	M8+M10	0.85	1.19
FRSR 15-19M8 / M10	534134	560284	100	3/8"	15-19	1.2 x 20	M5 x 16	M8+M10	0.85	1.19
FRSR 20-25 M8 / M10	534135	560285	100	1/2"	20-25	1.2 x 20	M5 x 16	M8+M10	0.85	1.19
FRSR 26-30 M8 / M10	534136	560286	100	3/4"	26-30	1.2 x 20	M5 x 16	M8+M10	0.85	1.19
FRSR 32-36 M8 / M10	534137	560287	100	1"	32-36	1.2 x 20	M5 x 16	M8+M10	0.85	1.19
FRSR 38-43 M8 / M10	534138	560288	50	1-1/4"	38-43	1.2 x 20	M5 x 20	M8+M10	0.85	1.19
FRSR 47-51 M8 / M10	534139	560289	50	1-1/2"	47-51	1.2 x 20	M5 x 20	M8+M10	0.85	1.19
FRSR 53-58 M8 / M10	534140	560290	50	-	53-58	1.2 x 20	M5 x 20	M8+M10	0.85	1.19
FRSR 60-64 M8 / M10	534141	560291	50	2"	60-64	1.2 x 20	M5 x 20	M8+M10	0.85	1.19
FRSR 63-67 M8 / M10	534142	560292	25	65	63-67	1.2 x 20	M5 x 20	M8+M10	0.85	1.19
FRSR 68-72 M8 / M10	534143	560294	25	-	68-72	1.5 x 20	M6 x 20	M8+M10	0.85	1.19
FRSR 75-80 M8 / M10	534144	560295	25	2-1/2"	75-80	1.5 x 20	M6 x 20	M8+M10	0.85	1.19
FRSR 81-86 M8 / M10	534145	560296	25	-	81-86	1.5 x 20	M6 x 20	M8+M10	1.6	2.24
FRSR 87-92 M8 / M10	534146	560297	25	3"	87-92	1.5 x 20	M6 x 20	M8+M10	1.6	2.24
FRSR 99-105 M8 / M10	534147	560298	20	3-1/2"	99-105	2.0 x 20	M6 x 20	M8+M10	1.6	2.24
FRSR 107-112 M8 / M10	534148	560299	20	-	107-112	2.0 x 20	M6 x 20	M8+M10	1.6	2.24
FRSR 113-118 M8 / M10	534149	560300	10	4"	113-118	2.0 x 20	M6 x 20	M8+M10	2.2	3.08
FRSR 125-130 M8 / M10	534150	560301	10	-	125-130	2.0 x 20	M6 x 20	M8+M10	2.2	3.08
FRSR 131-137 M8 / M10	560264	560302	10	-	131-137	2.0 x 20	M6 x 20	M8+M10	2.2	3.08
FRSR 138-142 M8 / M10	534151	560303	10	5"	138-142	2.0 x 20	M6 x 20	M8+M10	2.2	3.08
FRSR 148-153 M8 / M10	560265	560304	10	-	148-153	2.0 x 20	M6 x 20	M8+M10	2.2	3.08
FRSR 159-166 M8 / M10	534152	560305	8	6"	159-166	2.0 x 20	M6 x 20	M8+M10	2.2	3.08
FRSR 168-172 M8 / M10	560266	560306	8	-	168-172	2.0 x 20	M6 x 20	M8+M10	2.2	3.08
FRSR 175-183 M8 / M10	560272	560313	8	-	175-183	2.0 x 20	M6 x 20	M8+M10	2.2	3.08
FRSR 193-203 M8 / M10	560268	560307	8	-	193-203	2.0 x 20	M6 x 20	M8+M10	2.2	3.08
FRSR 200-212 M8 / M10	534153	560308	8	-	200-212	2.0 x 20	M6 x 20	M8+M10	2.5	3.5
FRSR 215-220 M8 / M10	534154	560309	8	8"	215-220	2.0 x 20	M6 x 20	M8+M10	2.5	3.5
FRSR 249-253 M8 / M10	560269	560310	8	-	249-253	2.0 x 20	M6 x 20	M8+M10	2.5	3.5
FRSR 292-296 M8 / M10	560273	560314	8	-	292-296	2.0 x 20	M6 x 20	M8+M10	2.5	3.5
FRSR 313-318 M8 / M10	560270	560311	8	-	313-318	2.0 x 20	M6 x 20	M8+M10	2.5	3.5
FRSR 320-328 M8 / M10	560271	560312	8	-	320-328	2.0 x 20	M6 x 20	M8+M10	2.5	3.5



PROPERTIES

- **Material:** Steel DD11 (material no. 1.0332 acc. to DIN EN 10111)
- **Zinc plating:** Electro zinc plated 5 - 9 μm
- **Connecting nut:** (up to FRSH 59-63) resistance welded, M8 and M8/M10 SW 13, M10 SW 17
- **Locking screw:** Flat head screw with combination recessed head
- **Sound insulation insert:** Material Silicone
- **Sound insulation:** for DIN 4109
- **Temperature range:** -40 °C to +220 °C
- **Hardness:** 60 \pm 5° Shore A
- **Fire behaviour:** DIN 4102: Class B2

ADVANTAGES/BENEFITS

- The special silicone sound insulation insert allows for use with average temperatures of up to +220°C
- The two screws allow for easy adjust-ment to suit the outer pipe diameter
- The screws' safety feature ensures trouble-free installation

INSTALLATION

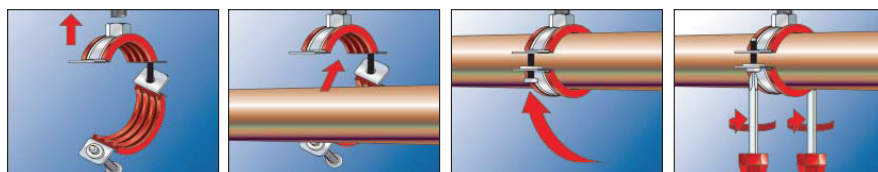

TECHNICAL DATA

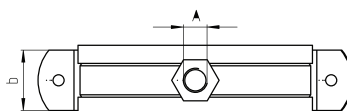
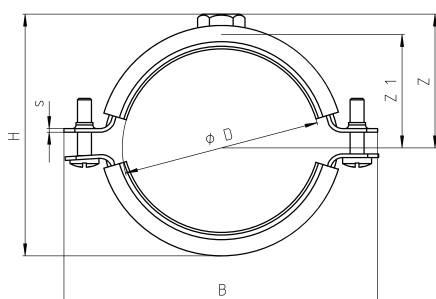

Item	Art.-NO.	Thread A	Size (inch)	Clamping range D (mm)	Width B (mm)	Height H (mm)	b x s (mm)	Hight Z (mm)	Locking Screw	Recommended load N _{rec} (kN)	Design load N _d (kN)	Sales unit (pcs)
FRSH 15 - 19	063490	M 8	3/8"	15-19	62	41	20 x 1.25	24	M 5	1.00	1.40	100
FRSH 20 - 24	063492	M 8	1/2"	20-24	68	46	20 x 1.25	26	M 5	1.00	1.40	100
FRSH 25 - 30	063494	M 8	3/4"	25-30	75	52	20 x 1.25	29	M 5	1.00	1.40	100
FRSH 32 - 37	063495	M 8	1"	32-37	80	59	20 x 1.25	33	M 5	1.00	1.40	100
FRSH 40 - 45	063498	M 8	1-1/4"	40-45	90	67	20 x 1.25	37	M 5	1.00	1.40	50
FRSH 48 - 53	063499	M 8	1-1/2"	48-53	97	75	20 x 1.25	41	M 5	1.00	1.40	50
FRSH 54 - 59	063500 ⁽¹⁾	M 8	-	54-49	104	81	20 x 1.25	44	M 5	1.00	1.40	50
FRSH 60 - 64	063502	M 8	2"	60-64	110	86	20 x 1.25	46	M 5	1.00	1.40	50
FRSH 68 - 73	063504 ⁽¹⁾	M 10	-	68-73	122	95	25 x 1.5	51	M 6	1.30	1.82	25
FRSH 72 - 78	063505	M 10	2-1/2"	72-78	130	100	25 x 1.5	55	M 6	1.30	1.82	25
FRSH 80 - 86	063511 ⁽¹⁾	M 10	-	80-86	130	108	25 x 1.5	58	M 6	1.30	1.82	25
FRSH 89 - 92	063513 ⁽¹⁾	M 10	3"	87-92	141	114	25 x 1.5	61	M 6	1.30	1.82	25
FRSH 95 - 103	063518 ⁽¹⁾	M 10	-	95-103	156	125	25 x 1.5	67	M 6	1.30	1.82	25
FRSH 102 - 116	063520	M 10	4"	102-116	172	140	25 x 2.0	74	M 6	2.0	2.80	20
FRSH 133 - 141	063537 ⁽¹⁾	M 8/M 10	5"	133-141	198	174	25 x 2.5	95	M 8	2.0	2.80	10
FRSH 159 - 168	091507 ⁽¹⁾	M 8/M 10	-	159-168	226	201	25 x 2.5	109	M 8	2.0	2.80	8

(1) Delivery time on request.

Picture Change

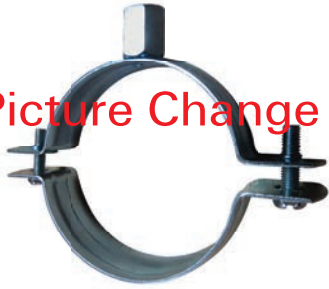

PROPERTIES

- **Material:** Steel
- **Zinc plating:** Electro zinc plated 5 - 9 µm
- **Standard:** comply with ASTM B633 SC 1
- Also available in SC3 on special request.
- Also available in dacromet finish 8.6 µm
- **Connecting nut:** resistance welded, M8, SW 13
- **Locking screw:** flat head screw with combination recessed head
- **Hardness:** 60 ± 5° Shore

ADVANTAGES/BENEFITS

- Simple installation due to large opening angle.
- Locking screw secured against loss.
- Combination connecting thread for cost-effective warehousing and flexibility at the construction site.

INSTALLATION

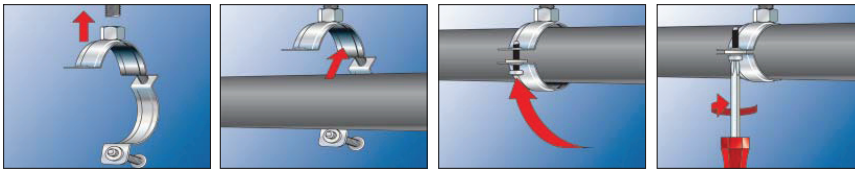

TECHNICAL DATA

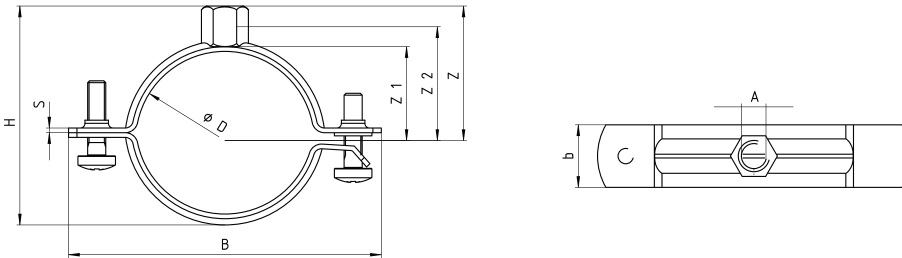

Item	Galvanized Art.-NO.	Dacromet Art.-NO.	Qty. per box pcs.	Size (inch)	Clamping range D (mm)	s x b (mm)	Screw M	Thread diameter A (mm)	Recommended load N _{rec} (kN)	Design load N _d (kN)
FRSR-N 11-14 M8 / M10	549800	560315	100	1/4"	11-14	1.2 x 20	M5 x 16	M8+M10	0.85	1.19
FRSR-N 15-19M8 / M10	549801	560316	100	3/8"	15-19	1.2 x 20	M5 x 16	M8+M10	0.85	1.19
FRSR-N 20-25 M8 / M10	549802	560317	100	1/2"	20-25	1.2 x 20	M5 x 16	M8+M10	0.85	1.19
FRSR-N 26-30 M8 / M10	549803	560318	100	3/4"	26-30	1.2 x 20	M5 x 16	M8+M10	0.85	1.19
FRSR-N 32-36 M8 / M10	549804	560319	100	1"	32-36	1.2 x 20	M5 x 16	M8+M10	0.85	1.19
FRSR-N 38-43 M8 / M10	549805	560320	50	1-1/4"	38-43	1.2 x 20	M5 x 20	M8+M10	0.85	1.19
FRSR-N 47-51 M8 / M10	549806	560321	50	1-1/2"	47-51	1.2 x 20	M5 x 20	M8+M10	0.85	1.19
FRSR-N 53-58 M8 / M10	549807	560322	50	-	53-58	1.2 x 20	M5 x 20	M8+M10	0.85	1.19
FRSR-N 60-64 M8 / M10	549808	560323	50	2"	60-64	1.2 x 20	M5 x 20	M8+M10	0.85	1.19
FRSR-N 63-67 M8 / M10	549809	560324	25	65	63-67	1.2 x 20	M5 x 20	M8+M10	0.85	1.19
FRSR-N 68-72 M8 / M10	549810	560325	25	-	68-72	1.5 x 20	M6 x 20	M8+M10	0.85	1.19
FRSR-N 75-80 M8 / M10	549811	560326	25	2-1/2"	75-80	1.5 x 20	M6 x 20	M8+M10	0.85	1.19
FRSR-N 81-86 M8 / M10	549812	560327	25	-	81-86	1.5 x 20	M6 x 20	M8+M10	1.6	2.24
FRSR-N 87-92 M8 / M10	549813	560328	25	3"	87-92	1.5 x 20	M6 x 20	M8+M10	1.6	2.24
FRSR-N 99-105 M8 / M10	549814	560329	20	3-1/2"	99-105	2.0 x 20	M6 x 20	M8+M10	1.6	2.24
FRSR-N 107-112 M8 / M10	549815	560330	20	-	107-112	2.0 x 20	M6 x 20	M8+M10	1.6	2.24
FRSR-N 113-118 M8 / M10	549816	560331	10	4"	113-118	2.0 x 20	M6 x 20	M6 x 20	2.2	3.08
FRSR-N 125-130 M8 / M10	549817	560332	10	-	125-130	2.0 x 20	M6 x 20	M8+M10	2.2	3.08
FRSR-N 131-137 M8 / M10	560274	560333	10	-	131-137	2.0 x 20	M6 x 20	M6 x 20	2.2	3.08
FRSR-N 138-142 M8 / M10	549818	560334	10	5"	138-142	2.0 x 20	M6 x 20	M8+M10	2.2	3.08
FRSR-N 148-153 M8 / M10	560275	560335	10	-	148-153	2.0 x 20	M6 x 20	M6 x 20	2.2	3.08
FRSR-N 159-166 M8 / M10	549819	560336	8	6"	159-166	2.0 x 20	M6 x 20	M8+M10	2.2	3.08
FRSR-N 168-172 M8 / M10	560276	560337	8	-	168-172	2.0 x 20	M6 x 20	M6 x 20	2.2	3.08
FRSR-N 175-183 M8 / M10	560281	560344	8	-	175-183	2.0 x 20	M6 x 20	M6 x 20	2.2	3.08
FRSR-N 193-203 M8 / M10	560277	560338	8	-	193-203	2.0 x 20	M6 x 20	M6 x 20	2.2	3.08
FRSR-N 200-212 M8 / M10	549820	560339	8	-	200-212	2.0 x 20	M6 x 20	M8+M10	2.5	3.5
FRSR-N 215-220 M8 / M10	549821	560340	8	8"	215-220	2.0 x 20	M6 x 20	M8+M10	2.5	3.5
FRSR-N 249-253 M8 / M10	560278	560341	8	-	249-253	2.0 x 20	M6 x 20	M6 x 20	2.5	3.5
FRSR-N 292-296 M8 / M10	560282	560344	8	-	292-296	2.0 x 20	M6 x 20	M6 x 20	2.5	3.5
FRSR-N 313-318 M8 / M10	560279	560342	8	-	313-318	2.0 x 20	M6 x 20	M6 x 20	2.5	3.5
FRSR-N 320-328 M8 / M10	560280	560343	8	-	320-328	2.0 x 20	M6 x 20	M6 x 20	2.5	3.5



PROPERTIES

- **Material:** Steel DD11 (material no. 1.0332 acc. to DIN EN 10111)
- **Zinc plating:** Electro zinc plated 5 - 9 µm
- **Standard:** comply with ASTM B633 SC1
- **Connecting nut:** resistance welded, M8 and M8/M10 SW 13, M10/M12 SW 17
- **Locking screw:** Flat head screw with combination recessed head

ADVANTAGES/BENEFITS

- The FRSN without the sound insulation insert is ideal for use in industrial applications and plastic pipes
- The combination connecting nut with thread M8/M10 allows for optimised mounting choices
- The two screws allow for ideal adaptation to suit the outer pipe diameter
- The screws' safety feature ensures trouble-free installation

INSTALLATION

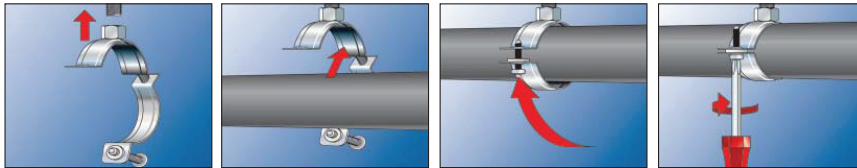

TECHNICAL DATA

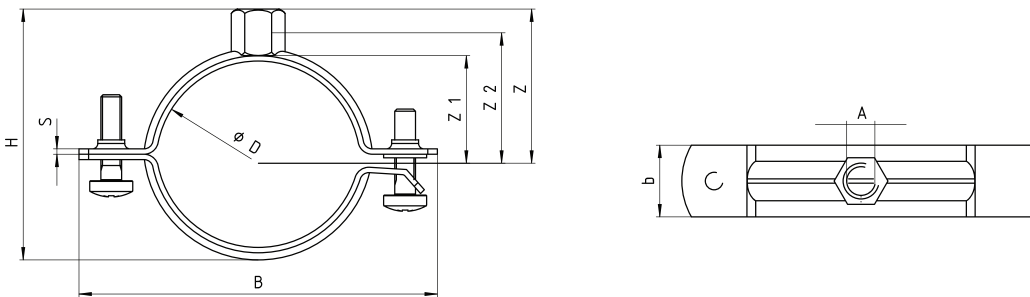

Item	Art.-NO.	Thread A	Size (inch)	Clamping range D (mm)	Width B B (mm)	Height H H (mm)	b x s (mm)	Hight Z Z (mm)	Locking Screw	Recommended load N _{rec} (kN)	Design load N _d (kN)	Sales unit (pcs)
FRSN 15 - 19 M8/M10	049459	M 8/M 10	3/8"	15-19	56	37	20 x 1.5	27	M 6	1.50	2.10	100
FRSN 21 - 23 M8/M10	049789	M 8/M 10	1/2"	21-23	60	41	20 x 1.5	28	M 6	1.50	2.10	100
FRSN 25 - 28 M8/M10	049790	M 8/M 10	3/4"	25-28	67	46	20 x 1.5	30	M 6	1.50	2.10	100
FRSN 32 - 36 M8/M10	049793	M 8/M 10	1"	32-36	74	54	20 x 1.5	34	M 6	1.50	2.10	100
FRSN 38 - 43 M8/M10	049794	M 8/M 10	1-1/4"	38-43	78	61	20 x 1.5	38	M 6	1.50	2.10	50
FRSN 44 - 49 M8/M10	049902	M 8/M 10	1-1/2"	44-49	88	67	20 x 1.5	41	M 6	1.50	2.10	50
FRSN 50 - 56 M8/M10	049922	M 8/M 10	-	50-56	92	74	20 x 1.5	43	M 6 x 16	1.50	2.10	50
FRSN 57 - 61 M8/M10	049944	M 8/M 10	2"	57-61	98	79	20 x 1.5	47	M 6	1.50	2.10	50
FRSN 63 - 70 M8/M10	049945	M 8/M 10	-	63-70	105	88	20 x 1.5	54	M 6	1.50	2.10	50
FRSN 70 - 77 M8/M10	049947	M 8/M 10	2-1/2"	70-77	112	95	20 x 1.5	55	M 6	1.50	2.10	25
FRSN 80 - 83 M8/M10	049948	M 8/M 10	-	80-83	116	101	20 x 1.5	58	M 6	1.50	2.10	25
FRSN 83 - 91 M8/M10	049979	M 8/M 10	3"	83-91	128	111	20 x 2.0	63	M 6	2.50	3.50	25
FRSN 100 - 106 M8/M10	050006	M 8/M 10	-	100-106	143	126	20 x 2.0	70	M 6	2.50	3.50	25
FRSN 108 - 114 M8/M10	050008	M 8/M 10	4"	108-114	156	134	20 x 2.0	75	M 6	2.50	3.50	25
FRSN 118 - 122 M8/M10	500744	M 8/M 10	-	118-122	160	142	20 x 2.0	78	M 6	2.50	3.50	25
FRSN 123 - 128 M8/M10	050009	M 8/M 10	-	123-128	173	149	25 x 2.5	82	M 6	2.50	3.50	25
FRSN 131 - 136 M8/M10	050010	M 8/M 10	-	131-136	176	157	25 x 2.5	86	M 6	2.50	3.50	25
FRSN 137 - 146 M8/M10	050023	M 8/M 10	5"	137-146	180	167	25 x 2.5	91	M 6	2.50	3.50	25
FRSN 146 - 156 M8/M10	500746	M 8/M 10	-	146-156	195	177	25 x 2.5	96	M 6	2.50	3.50	25
FRSN 159 - 165 M10/M12	500747	M 10/M 12	-	159-165	203	191	25 x 2.5	106	M 6	2.50	3.50	25
FRSN 166 - 175 M10/M12	500748 ¹⁾	M 10/M 12	-	166-175	211	201	25 x 2.5	110	M 8	2.50	3.50	20
FRSN 200 - 206 M10/M12	500751 ¹⁾	M 10/M 12	-	200-206	248	232	25 x 2.5	126	M 8	2.50	3.50	10
FRSN 210 - 219 M10/M12	500752 ¹⁾	M 10/M 12	8"	210-219	261	245	25 x 2.5	133	M 8	2.50	3.50	10

(1) The band of the clamp is perforated from Ø 166 and connected with locking screw and nut.

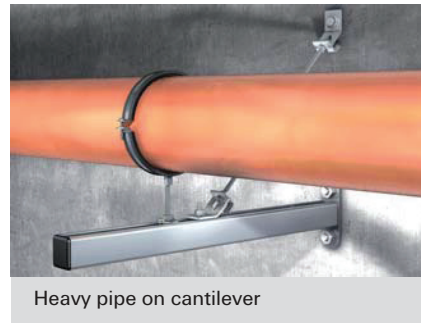

PROPERTIES

- **Material:** Steel DD11 (material no. 1.0332 acc. to DIN EN 10111)
- **Zinc plating:** Electro zinc plated 5 - 9 µm
Also available in HDG on request.
- **Connecting nut:** M 10/M 12 = SW 17, M 12/ M 16 = SW 22, M 16 = SW 24
- **Material Sound insulation insert:** EPDM; chlorine-free; silicone-free
- **Temperature range:** -50 °C to +110 °C
- **Hardness:** 45 ± 5° Shore A
- **Fire behaviour:** DIN 4102: Class B2

ADVANTAGES/BENEFITS

- High tested loads guarantees safe functioning of the FRSM
- The combination connecting nut with thread M10/M12, M12/M16 or M16 allows for optimised mounting choices
- From Ø 124 mm it is possible to install with 2 threaded rods, e.g. for the fixing of cast iron roof drainage pipes
- The two screws allow for easy adjustment to suit the outer pipe diameter
- The screws' safety features ensures trouble-free installation

INSTALLATION

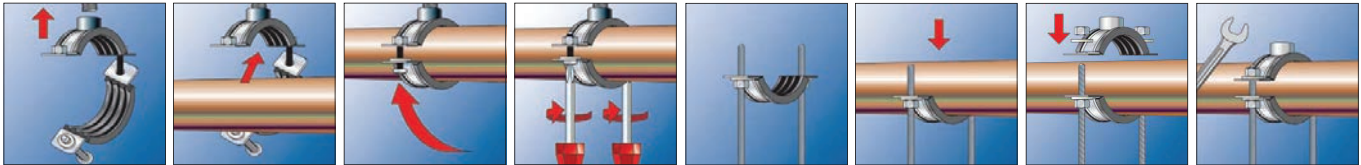

TECHNICAL DATA

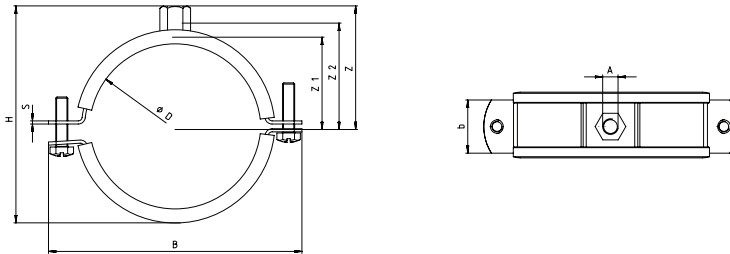

Item	Art.-NO.	Thread A	Size (inch)	Clamping range D (mm)	Width B B (mm)	Height H H (mm)	b x s (mm)	Height Z Z (mm)	Locking Screw	Recommended load N _{rec} (kN)	Design load N _d (kN)	Sales unit (pcs)
FRSM 1/2" M10/M12	504589	M 10/M 12	1/2"	19-23	76	57	25 x 2.5	39	M 6	2.50	3.50	50
FRSM 3/4" M10/M12	504590	M 10/M 12	3/4"	24-29	80	63	25 x 2.5	42	M 6	2.50	3.50	50
FRSM 1" M10/M12	504591	M 10/M 12	1"	33-36	89	70	25 x 2.5	45	M 6	2.50	3.50	50
FRSM 1 1/4" M10/M12	504592	M 10/M 12	1-1/4"	40-45	98	79	25 x 2.5	50	M 6	2.50	3.50	20
FRSM 1 1/2" M10/M12	093700	M 10/M 12	1-1/2"	47-52	105	86	25 x 2.5	53	M 6	2.50	3.50	20
FRSM 53 - 58 M10/M12	093701	M 10/M 12	-	53-58	111	91	25 x 2.5	55	M 6	2.50	3.50	20
FRSM 2" M10/M12	093702	M 10/M 12	2"	60-65	118	99	25 x 2.5	60	M 6	2.50	3.50	20
FRSM 2 1/2" M10/M12	093703	M 10/M 12	2-1/2"	73-78	136	113	30 x 3.0	67	M 8	3.00	4.20	20
FRSM 79 - 85 M10/M12	504593	M 10/M 12	-	79-85	144	120	30 x 3.0	70	M 8	3.00	4.20	20
FRSM 3" M10/M12	093704	M 10/M 12	3"	88-93	152	129	30 x 3.0	75	M 8	3.00	4.20	20
FRSM 102 M10/M12	093705	M 10/M 12	-	100-106	166	142	30 x 3.0	81	M 8	3.00	4.20	20
FRSM 4" M10/M12	093707	M 10/M 12	4"	108-116	175	152	30 x 3.0	86	M 8	3.00	4.20	20
FRSM 124 - 129 M10/M12	093709 ⁽¹⁾	M 10/M 12	-	124-129	194	165	30 x 3.0	92	M 8	3.00	4.20	20
FRSM 133 M10/M12	093710 ⁽¹⁾	M 10/M 12	-	131-137	202	173	30 x 3.0	97	M 8	3.00	4.20	20
FRSM 5" M10/M12	093711 ⁽¹⁾	M 10/M 12	5"	138-145	210	180	30 x 3.0	100	M 8	3.00	4.20	20
FRSM 160 M10/M12	093712 ⁽¹⁾	M 10/M 12	-	156-162	227	198	30 x 3.0	109	M 8	3.00	4.20	20
FRSM 6" M10/M12	093713 ⁽¹⁾	M 10/M 12	6"	165-171	255	207	30 x 3.0	114	M 8	3.00	4.20	20
FRSM 7" M10/M12	093714 ⁽¹⁾	M 10/M 12	7"	188-194	278	230	30 x 3.0	125	M 8	3.00	4.20	10
FRSM 200 M10/M12	093715 ⁽¹⁾	M 10/M 12	-	196-203	287	239	30 x 3.0	130	M 8	3.00	4.20	10
FRSM 212 M12/M16	505453 ⁽¹⁾	M 12/M 16	-	205-214	289	264	40 x 4.0	147	M 12	5.00	7.00	10
FRSM 8" M12/M16	505454 ⁽¹⁾	M 12/M 16	8"	219-225	300	272	40 x 4.0	152	M 12	5.00	7.00	10
FRSM 250 M12/M16	505455 ⁽¹⁾	M 12/M 16	-	244-250	325	300	40 x 4.0	165	M 12	5.00	7.00	10
FRSM 10" M12/M16	505456 ⁽¹⁾	M 12/M 16	10"	267-273	348	323	40 x 4.0	177	M 12	5.00	7.00	10
FRSM 300 M12/M16	505457 ⁽¹⁾	M 12/M 16	-	297-304	379	354	40 x 4.0	192	M 12	5.00	7.00	10
FRSM 12" M12/M16	505458 ⁽¹⁾	M 12/M 16	12"	320-328	403	378	40 x 4.0	204	M 12	5.00	7.00	10
FRSM 348 - 356 M16	504594 ⁽¹⁾	M 16	-	348-356	480	403	50 x 5.0	213	M 16	8.00	11.20	1
FRSM 364 - 372 M16	504595 ⁽¹⁾	M 16	-	364-372	496	419	50 x 5.0	221	M 16	8.00	11.20	1
FRSM 400 - 409 M16	504596 ⁽¹⁾	M 16	-	400-409	533	456	50 x 5.0	240	M 16	8.00	11.20	1
FRSM 454 - 462 M16	504597 ⁽¹⁾	M 16	-	454-462	586	509	50 x 5.0	266	M 16	8.00	11.20	1
FRSM 500 - 508 M16	504598 ⁽¹⁾	M 16	-	500-508	632	555	50 x 5.0	290	M 16	8.00	11.20	1

(1) The bond of the clamp is perforated from Ø 124 and connected with locking screw and nut.

Sprinkler clamp FRSP C



Fire fighting pipe

PROPERTIES

- **Material:** Carbon Steel Q 235
- **Zinc plating:** Electro zinc plated 5 - 9 µm
- **Standard:** comply with ASTM B633 SC1
- Also available in SC3 on special request.
- Also available in green galvanization.

ADVANTAGES/BENEFITS

- The FM-approval guarantees independantly tested safety for the use in sprinkler systems.
- The sprinkler loop with clearance hole for easy fixing with threaded rod and nut.
- The UL approval guarantees the use in firefighting and sprinklar applications
- Easy to install without tools

APPROVALS



INSTALLATION

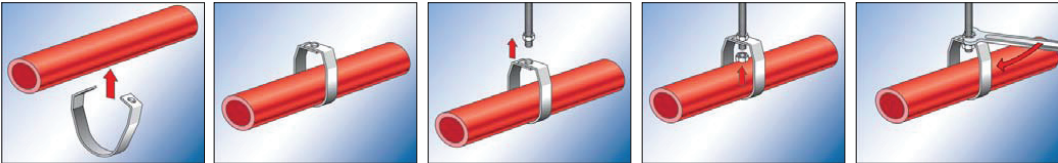

TECHNICAL DATA

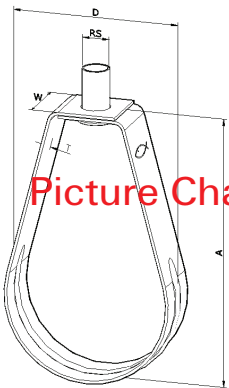

Picture Change

Item (in)	Galvanized Art.-NO.	Green galvanized Art.-NO.	Clamping range D (mm)	Road size RS (mm)	Height A (mm)	Max. rec. load P (kN)	Width W (mm)	Thickness T (mm)	Sale unit (pcs.)
FRSP C 1/2"	516662	560372	19-23	M 10	72	1.3	16	1.2	100
FRSP C 3/4"	516663	560373	25-29	M 10	78	1.3	16	1.2	100
FRSP C 1"	516664	560374	33-36	M 10	86	1.3	16	1.2	100
FRSP C 1-1/4"	516665	560375	40-45	M 10	94	1.3	16	1.2	100
FRSP C 1-1/2"	516666	560376	47-52	M 10	99	1.3	16	1.2	100
FRSP C 2"	516667	560377	60-65	M 10	109	1.3	16	1.2	100
FRSP C 2-1/2"	516668	560378	73-78	M 10	141	4.5	19	22	60
FRSP C 3"	516669	560379	88-93	M 10	162	4.5	19	22	60
FRSP C 4"	516670	560380	110-116	M 10	195	5.0	19	22	24
FRSP C 5"	532356	560381	138-145	M 12	226	5.0	19	2.5	24
FRSP C 6"	516671	560382	165-171	M 12	267	5.6	19	3	24
FRSP C 8"	516672	560383	217-221	M 12	316	5.6	19	3	12



PROPERTIES

- **Material:** Carbon Steel Q 235
- **Zinc plating:** Electro zinc plated 5 - 9 µm
- **Standard:** comply with ASTM B633 SC 1
- Also available in SC3 on special request.
- Also available in green galvazation.
- Comply with MSS SP 69/MSS SP 68 Type-1
- Sizes for CHW pipe available on request.

ADVANTAGES/BENEFITS

Heavy duty Clevis Hanger.
Designed for chilled water pipe work and fire fighting systems.
Design allows vertical adjustment of pipe after installation.
Nuts above Clevis must be tightened securely to ensure proper hanger performance.

APPROVALS



TECHNICAL DATA

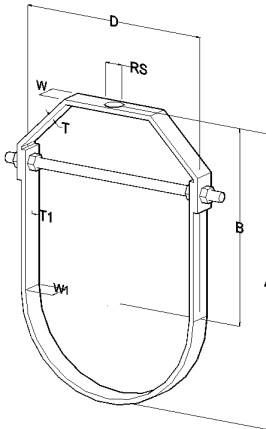

Item	Galvanized Art.-NO.	Green galvanized Art.-NO.	Clamping range D (mm)	Road size RS (mm)	Height A (mm)	Distance center to top B (mm)	Max. rec. load (kN)	W (mm)	T (mm)	W-1 (mm)	T-1 (mm)	Sales unit (pcs.)
FCH 1/2"	532187	560346	19-23	M 10	51	37.6	2.7	19	2.5	19	2	150
FCH 3/4"	532190	560347	25-29	M 10	58.4	42.3	2.7	19	2.5	19	2	120
FCH 1	532195	560348	33-36	M 10	70	50.5	2.7	19	2.5	19	2	120
FCH 1-1/4"	532197	560349	40-45	M 10	84	59.9	2.7	25	2.5	25	2	56
FCH 1-1/2"	532198	560350	47-52	M 10	100	72.9	2.7	25	2.5	25	2	56
FCH 2"	516695	560351	60-65	M 10	114.3	81.2	2.7	25	3	25	2	56
FCH 2-1/2"	516696	560352	71-75	M 12	132.7	92.7	5.0	30	3	30	2.5	60
FCH 3"	516697	560353	87-92	M 12	152.6	104.4	5.0	30	3.5	30	2.5	48
FCH 4"	516699	560354	110-116	M 16	192	130.4	5.0	30	5	30	3	24
FCH 5"	516700	560355	138-145	M 16	237.8	161.4	6.4	30	6	30	4	24
FCH 6"	516701	560356	165-171	M 20	272.3	181.2	8.6	38	8	38	5	12
FCH 8"	516702	560357	217-221	M 20	333.4	216.4	8.9	38	9	38	5	6
* FCH 10"	516703	560358	271-275	M 20	400	254.5	16.0	50	9	50	6	2
* FCH 12"	516704	560359	321-326	M 20	479.1	308.2	16.9	50	9	50	6	2

(1) * 516703, 516704 approvals not available



Riser pipe

PROPERTIES

- **Material:** Carbon Steel Q 235
- **Zinc plating:** Electro zinc plated 5 - 9 µm
- **Standard:** comply with ASTM B633 SC 1
- Also available in SC3 on special request.
- Also available in green galvization.
- Comply with MSS SP 69/MSS SP 68 Type-42

ADVANTAGES/BENEFITS

- Riser clamps are used for support of vertical piping by friction, no welding required on pipe.
- The UL approval guarantees tested safety for fire fighting riser pipes.
- Comply with manufacturer's standardization society MSS SP 69/MSS SP 68

APPROVALS



TECHNICAL DATA

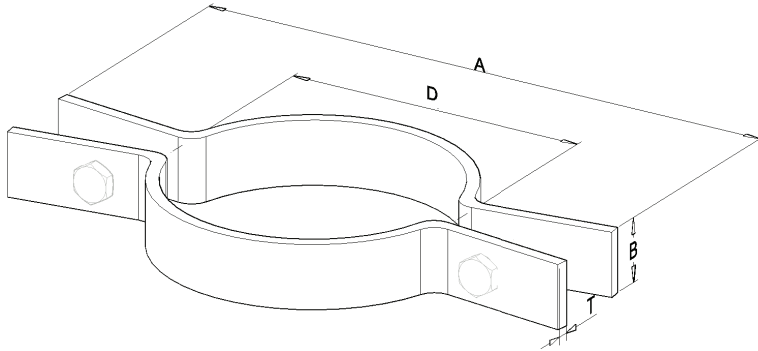

Item	Galvanized Art.-NO.	Green galvanized Art.-NO.	Clamping range D (mm)	Bolt size (mm)	Widht A (mm)	Bolt diameter B (mm)	Max. rec. load (kN)	T (mm)	Torque (N.m)	Sales unit (pcs.)
RCWR 1/2"	516673	560360	19-23	M 10	215	25	1.0	5	41	35
RCWR 3/4"	516674	560361	24-28	M 10	228.5	25	1.0	5	41	30
RCWR 1"	516675	560362	31-35	M 10	229.5	25	1.0	5	31	25
RCWR 1-1/4"	516676	560363	40-44	M 10	240.5	25	1.1	5	31	25
RCWR 1-1/2"	516677	560364	46-50	M 10	251	25	1.1	3	31	25
RCWR 2"	516678	560365	56 - 61	M 10	261.6	30	1.3	5	31	25
RCWR 2-1/2"	532380	560366	75 - 80	M 10	281.3	30	1.8	5	31	25
RCWR 3"	516679	560367	88 - 93	M 10	298.5	30	2.2	5	45	20
RCWR 4"	516680	560368	108 - 115	M 12	328.6	38	3.3	6	75	12
RCWR 5"	516681	560369	133 - 140	M 12	362	38	6.7	6	75	12
RCWR 6"	516682	560370	167 - 172	M 12	393.7	50	7.1	6	75	8
RCWR 8"	516683	560371	219 - 225	M 16	463.5	50	11.1	9.5	129	4



Chilled water pipe support

PROPERTIES

- Density: 1268 kg/m³
- Thermal conductivity: 0.219 W/m.k
- Temperature range: from 0 to 50° C
- BS-3974-1 : 1974

TECHNICAL DATA

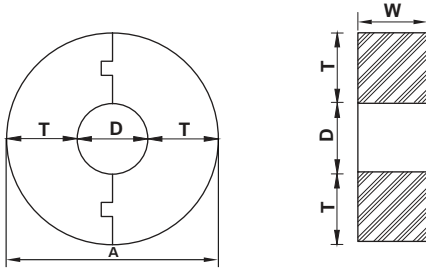

Si.No.	Nom. Pipe size in	D (mm)	T= 19.0				T= 25.0				T= 32.0				T= 38.0			
			Art.No.	Sales unit (pcs.)	W (mm)	A (mm)	Art.No.	Sales unit (pcs.)	W (mm)	A (mm)	Art.No.	Sales unit (pcs.)	W (mm)	A (mm)	Art.No.	Sales unit (pcs.)	W (mm)	A (mm)
1.	1/2"	21.3	549822	250	30	59	532357	180	30	71	549842	108	30	85	532833	120	30	97
2.	3/4"	26.7	549823	184	30	65	532358	160	30	77	549843	108	30	91	532834	90	30	103
3.	1"	33.4	549824	160	30	71	532359	120	30	83	549844	90	30	97	532835	60	30	109
4.	1-1/4"	42.1	549825	126	30	80	532360	100	30	92	549845	62	30	106	532836	50	30	118
5.	1-1/2"	48.2	549826	108	30	86	532361	90	30	98	549846	62	30	112	532837	50	30	124
6.	2"	60.3	549827	90	30	98	532362	60	30	110	549847	56	30	124	532838	40	30	136
7.	2-1/2"	73.0	549828	44	38	111	532363	35	38	123	549848	28	38	137	532839	28	38	149
8.	3"	89.9	549829	36	38	127	532364	28	38	139	549849	15	38	153	532840	13	38	165
9.	3-1/2"	102.6	549830	32	38	140	532365	28	38	152	549850	13	38	166	532841	13	38	178
10.	4"	114.3	549831	28	38	152	532366	24	38	164	549851	13	38	178	532842	13	38	190
11.	5"	141.3	549832	13	38	179	532367	13	38	191	549852	11	38	205	532843	11	38	217
12.	6"	168.3	549833	9	50	206	532369	7	50	218	549853	7	50	232	532844	7	50	244
13.	8"	219.1	549834	5	50	257	532370	5	50	269	549854	5	50	283	532845	5	50	295
14.	10"	273.0	549835	5	50	311	532371	5	50	323	549855	5	50	337	532846	5	50	349
15.	12"	324.8	549836	5	50	362	532373	5	50	374	549856	5	50	388	532847	5	50	400
16.	14"	356.6	549837	5	50	394	532374	5	50	406	549857	5	50	420	532848	5	50	432
17.	16"	406.4	549838	1	50	444	532375	1	50	456	549858	1	50	470	532849	1	50	482
18.	18"	457.2	549839	1	50	495	532376	1	50	507	549859	1	50	521	532850	1	50	533
19.	20"	508.0	549840	1	50	546	532377	1	50	558	549860	1	50	572	532851	1	50	584
20.	24"	610.6	549841	1	50	648	532378	1	50	660	549861	1	50	674	532852	1	50	686

Si.No.	Nom. Pipe size in	D (mm)	T= 50.0				T= 65.0				T= 75.0			
			Art.No.	Sales unit (pcs.)	W (mm)	A (mm)	Art.No.	Sales unit (pcs.)	W (mm)	A (mm)	Art.No.	Sales unit (pcs.)	W (mm)	A (mm)
1.	1/2"	21.3	532853	64	30	121	533385	40	30	151	533405	20	30	171
2.	3/4"	26.7	532854	50	30	127	533386	40	30	157	533406	20	30	177
3.	1"	33.4	532855	40	30	133	533387	20	30	163	533407	20	30	183
4.	1-1/4"	42.1	532856	40	30	142	533388	18	30	172	533408	20	30	192
5.	1-1/2"	48.2	532857	40	30	148	533389	18	30	178	533409	18	30	198
6.	2"	60.3	532858	40	30	160	533390	18	30	190	533410	12	30	210
7.	2-1/2"	73.0	532859	16	38	173	533391	13	38	203	533411	11	38	223
8.	3"	89.9	532860	13	38	189	533392	11	38	219	533412	9	38	239
9.	3-1/2"	102.6	532861	13	38	202	533393	9	38	232	533413	9	38	252
10.	4"	114.3	532862	12	38	214	533394	9	38	244	533414	9	38	264
11.	5"	141.3	532863	10	38	241	533395	7	38	271	533415	7	38	291
12.	6"	168.3	532864	7	50	268	533396	5	50	298	533416	5	50	318
13.	8"	219.1	532865	5	50	319	533397	5	50	349	533417	5	50	369
14.	10"	273.0	532866	5	50	373	533398	5	50	403	533418	5	50	423
15.	12"	324.8	532867	5	50	424	533399	5	50	454	533419	5	50	474
16.	14"	356.6	532868	5	50	456	533400	1	50	486	533420	1	50	506
17.	16"	406.4	532869	1	50	506	533401	1	50	536	533421	1	50	556
18.	18"	457.2	532870	1	50	557	533402	1	50	587	533422	1	50	607
19.	20"	508.0	532871	1	50	608	533403	1	50	638	533423	1	50	658
20.	24"	610.6	532872	1	50	710	533404	1	50	740	533424	1	50	760

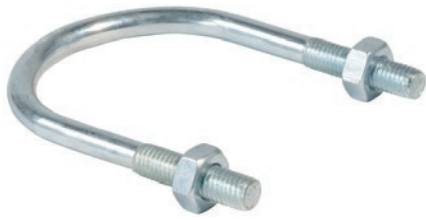

PROPERTIES

- **Material:** Steel with min. tensile strength of 360 N/mm²
- **Zinc plating:** Electro zinc plated, $\geq 5 \mu\text{m}$
Also available with Rubber lining.

ADVANTAGES/BENEFITS

- Good for use as a guide mounting.
- The U-Bolt's two nuts allows for ideal adaptation to suit the outer pipe diameter.

TECHNICAL DATA

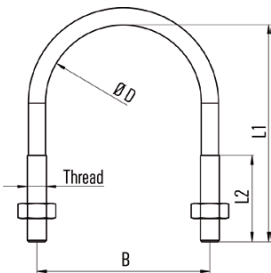

Item	Art.-NO.	Qty. per box (pcs.)	Outer carton (pcs)	Thread M	Size (inch)	Width	Length	Length
						B (mm)	L ₁ (mm)	L ₂ (mm)
ETR 8 - 13	024415	10	100	M 6	1/4"	20	30	18
ETR 12 - 17	024416	10	100	M 6	3/8"	24	35	18
ETR 15 - 21	024417	10	100	M 6	1/2"	28	40	22
ETR 20 - 27	024418	10	50	M 8	3/4"	36	50	30
ETR 26 - 34	024419	10	50	M 8	1"	43	55	30
ETR 33 - 42	024420	10	50	M 8	1-1/4"	51	68	35
ETR 40 - 49	024421	10	50	M 8	1-1/2"	58	70	35
ETR 50 - 60	024422	10	50	M 8	2"	69	80	35
ETR 60 - 70	024423	10	50	M 10	-	82	100	38
ETR 66 - 76	024424	10	50	M 10	2-1/2"	88	110	45
ETR 70 - 82	024425	10	50	M 10	-	94	115	45
ETR 80 - 90	024426	10	50	M 10	3"	102	115	45
ETR 90 - 102	024427	5	50	M 12	3-1/2"	116	145	50
ETR 100 - 108	024428	5	50	M 12	-	122	150	50
ETR 102 - 114	024429	5	50	M 12	4"	128	156	55
ETR 121 - 127	024430	5	50	M 12	-	141	170	55
ETR 126 - 133	024431	5	50	M 12	-	147	180	65
ETR 131 - 140	024432	5	25	M 14	5"	156	185	65
ETR 143 - 153 ¹⁾	024433	5	25	M 14	-	169	193	65
ETR 150 - 159	024434	5	25	M 14	-	175	200	65
ETR 168	024435	5	25	M 14	6"	184	210	65
ETR 193.7	024436	5	25	M 14	-	209	232	65
ETR 219	024437	5	25	M 14	8"	236	270	65

¹⁾ Delivery time on request.



Suspended pipe support

PROPERTIES

- **Material:** Carbon Steel Q 235
- **Zinc plating:** Electro zinc plated 5 - 9 µm
- **Standard:** comply with ASTM B633 SC1
Also available in SC3 on special request.

TECHNICAL DATA

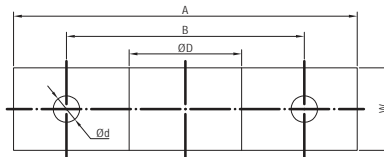
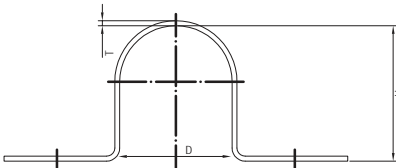

Si.No.	Art. No.	D (mm)	A (mm)	B (mm)	t x w (mm)	Bolt size (mm)	Sales unit (pcs.)	Si.No.	Art. No.	D (mm)	A (mm)	B (mm)	t x w (mm)	Bolt size (mm)	Sales unit (pcs.)
1.	541787	21	81	54	2 x 25	8	100	51.	541825	264	376	334	3 x 38	12	5
2.	541788	27	87	60	2 x 25	8	100	52.	541826	268	380	338	3 x 38	12	5
3.	541789	33	93	66	2 x 25	8	100	53.	541827	272	384	342	3 x 38	12	5
4.	516708	42	102	75	2 x 25	8	100	54.	535123	283	395	353	3 x 38	12	5
5.	516709	48	108	81	2 x 25	8	100	55.	535125	291	403	361	3 x 38	12	5
6.	541790	59	119	92	2 x 25	8	100	56.	532406	295	407	365	3 x 38	12	3
7.	541791	65	125	98	2 x 25	8	100	57.	541828	298	410	368	3 x 38	12	-
8.	535020	72	132	105	2 x 25	8	50	58.	541829	311	423	381	3 x 38	12	3
9.	516711	76	172	136	2 x 25	10	50	59.	541830	318	430	388	3 x 38	12	3
10.	541792	80	176	140	2 x 25	10	50	60.	532816	323	435	393	3 x 38	12	3
11.	541793	84	180	144	2 x 25	10	30	61.	535128	337	449	407	4 x 50	12	3
12.	541795	86	182	146	2 x 25	10	30	62.	541831	349	461	419	4 x 50	12	3
13.	541796	89	185	149	2 x 25	10	-	63.	541832	355	467	425	4 x 50	12	3
14.	541797	92	188	152	2 x 25	10	-	64.	541833	361	473	431	4 x 50	12	3
15.	535022	98	194	158	2 x 25	10	30	65.	535131	369	481	439	4 x 50	12	3
16.	541798	102	198	162	3 x 25	10	30	66.	541834	373	485	443	4 x 50	12	3
17.	541799	106	202	166	3 x 25	10	30	67.	541835	387	499	457	4 x 50	12	3
18.	541800	110	206	170	3 x 25	10	30	68.	535133	393	505	463	4 x 50	12	3
19.	541801	114	210	174	3 x 25	10	30	69.	541836	399	511	469	4 x 50	12	3
20.	541802	118	214	178	3 x 25	10	30	70.	541837	403	515	473	4 x 50	12	-
21.	541803	122	218	182	3 x 25	10	-	71.	541838	405	517	475	4 x 50	12	3
22.	532394	126	222	186	3 x 25	10	30	72.	541839	419	531	489	4 x 50	12	3
23.	541804	134	230	194	3 x 25	10	20	73.	541840	423	535	493	4 x 50	12	-
24.	541806	138	234	198	3 x 25	10	-	74.	541841	431	543	501	4 x 50	12	3
25.	541807	141	237	201	3 x 25	10	20	75.	541842	444	556	514	4 x 50	12	3
26.	532395	148	244	208	3 x 25	10	20	76.	541843	453	565	523	4 x 50	12	-
27.	541808	152	248	212	3 x 25	10	-	77.	532821	456	568	526	4 x 50	12	3
28.	541809	156	252	216	3 x 25	10	20	78.	541844	470	582	540	4 x 50	12	3
29.	541810	160	256	220	3 x 25	10	-	79.	541845	473	585	543	4 x 50	12	-
30.	541811	164	260	224	3 x 25	10	10	80.	541846	483	595	553	4 x 50	12	3
31.	532397	168	264	228	3 x 25	10	10	81.	541847	495	607	565	4 x 50	12	3
32.	535027	172	268	232	3 x 25	10	10	82.	541848	506	618	576	4 x 50	12	3
33.	541812	177	273	237	3 x 25	10	-	83.	541849	521	633	591	4 x 50	12	3
34.	532398	179	275	239	3 x 25	10	10	84.	532824	533	645	603	4 x 50	12	3
35.	541813	183	279	243	3 x 38	10	10	85.	541850	536	648	606	4 x 50	12	-
36.	541814	188	284	248	3 x 38	10	-	86.	535142	546	658	616	4 x 50	12	2
37.	541815	191	287	251	3 x 38	10	10	87.	541851	566	678	636	4 x 50	12	2
38.	541816	198	294	258	3 x 38	10	-	88.	535143	572	684	642	4 x 50	12	2
39.	541817	202	298	262	3 x 38	10	10	89.	541852	584	696	654	4 x 50	12	2
40.	532400	205	301	265	3 x 38	10	10	90.	541853	587	699	657	4 x 50	12	-
41.	541818	210	306	270	3 x 38	10	5	91.	541854	608	720	678	4 x 50	12	2
42.	541819	214	310	274	3 x 38	10	-	92.	535144	638	750	708	4 x 50	12	2
43.	541820	218	314	278	3 x 38	10	5	93.	541855	647	759	717	4 x 50	12	2
44.	535032	223	319	283	3 x 38	10	5	94.	532828	658	770	728	4 x 50	12	2
45.	541821	232	328	292	3 x 38	10	5	95.	541856	673	785	743	4 x 50	12	2
46.	541822	238	334	298	3 x 38	10	-	96.	541857	685	797	755	4 x 50	12	2
47.	532403	241	337	301	3 x 38	10	5	97.	541858	709	821	779	4 x 50	12	2
48.	541823	244	356	314	3 x 38	12	5	98.	541859	739	851	809	4 x 50	12	2
49.	541824	251	363	321	3 x 38	12	5	99.	541860	759	871	829	4 x 50	12	2
50.	535034	257	369	327	3 x 38	12	5								

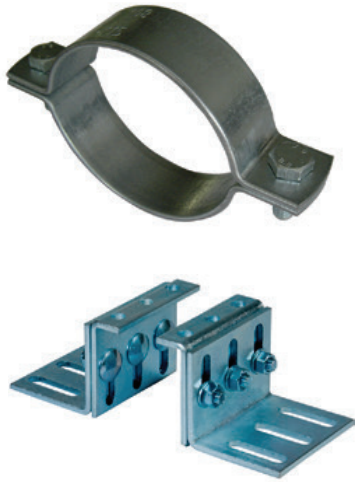

PROPERTIES

- **FFPS:** S185-Z-150 NA-AK (Material no. 1.0035) acc. to DIN EN 10035
- **FFPK:** S234 JR (Material No. 1.0037) acc. to DIN EN 10025
- **Zinc plating:** Electro zinc plated, min 5µm Available on HDG on special request.
- **Fixpoint clamp:** Prevent unwanted movement of the pipe
- **Fixpoint clamp:** Ensure expansion in the desired direction.
- **Loads applicable:** For steel pipes

TECHNICAL DATA

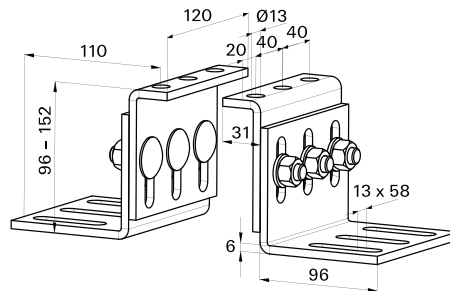
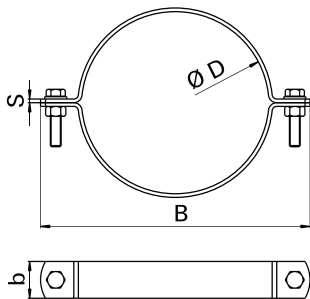

Item	Art.-NO.	Clamping range	Reqd. torque with Gr 8.8 M 12 bolt (Nim.)	Size (inch)	Width B (mm)	Locking screw	b x s (mm)	Sales unit (pcs.)
		D (mm)						
FFPS								
FFPS 2"	48510	56 - 61	80	2"	137	M 12	40 x 4	1
FFPS 2 1/2"	48511	75 - 80	80	2 1/2"	156	M 12	40 x 4	1
FFPS 3"	48512	88 - 93	80	3"	170	M 12	40 x 4	1
FFPS 4"	48513	108 - 115	80	4"	191	M 12	40 x 4	1
FFPS 5"	48660	133 - 140	80	5"	217	M 12	40 x 4	1
FFPS 159 - 166	48662	159 - 166	80	159 - 166	243	M 12	40 x 4	1
FFPS 6"	48663	167 - 172	80	6"	250	M 12	40 x 4	1
FFPS 8"	48664	219 - 225	80	8"	303	M 12	40 x 4	1
FFPS 10"	48665	267 - 274	80	10"	351	M 12	40 x 4	1
FFPK	48666	-	-	-	-	-	-	1

LOADS

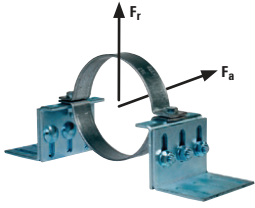
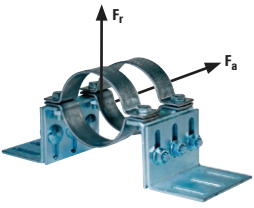
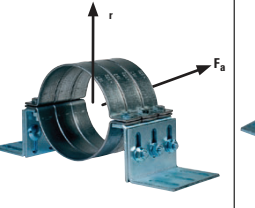
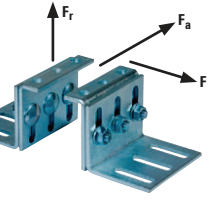
Type				
Load for Zinc Plated Clamp with Steel pipes	Fixpoint 1 clamp Max. recom. load axial $F_a = 8000$ N radial $F_r = 4660$ N	Fixpoint 2 clamps Max. recom. load axial $F_a = 16000$ N radial $F_r = 9320$ N	Fixpoint 3 clamps Max. recom. load axial $F_a = 24000$ N radial $F_r = 13980$ N	FFPK Saddle max. recom. loads radial $F_r = 42000$ N lateral $F_l = 17500$ N
Load for HDG Clamp with Steel pipes	Fixpoint 1 clamp Max. recom. load axial $F_a = 6000$ N radial $F_r = 4660$ N	Fixpoint 2 clamps Max. recom. load axial $F_a = 12000$ N radial $F_r = 9320$ N	Fixpoint 3 clamps Max. recom. load axial $F_a = 18000$ N radial $F_r = 13980$ N	FFPK Saddle max. recom. loads radial $F_r = 42000$ N lateral $F_l = 17500$ N
*Load for Zinc Plated & HDG Clamps with Plastic pipes	Fixpoint 1 clamp Max. recom. load axial $F_a = 1000$ N radial $F_r = 4660$ N	Fixpoint 2 clamps Max. recom. load axial $F_a = 2000$ N radial $F_r = 9320$ N	Fixpoint 3 clamps Max. recom. load axial $F_a = 3000$ N radial $F_r = 13980$ N	FFPK Saddle max. recom. loads radial $F_r = 42000$ N lateral $F_l = 17500$ N

(1) PPR pipes & UPVC pipes



GL



FSC1



SBS

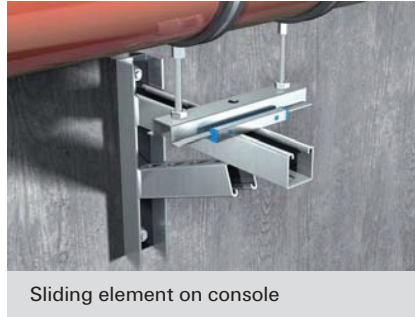

Sliding element on console

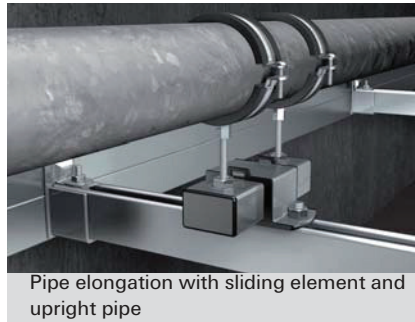

Pipe elongation with sliding element and upright pipe

PROPERTIES - GL

- **Material:** Steel S235 JR (material no. 1.0037) acc. to DIN EN10025
- **Zinc plating:** Electro zinc plated, min. 8 µm
- **Material sliding strips:** Nylon 6.6
- **Adhesion friction factor:** 0.27 - 0.3
- **Sliding friction factor:** 0.13 - 0.17
- **Thermal load capacity:** up to + 130 °C

PROPERTIES - FSC1

- **Material:** Steel DD 11 (material no. 1.0332) acc. to DIN EN 10111.
- **Zinc plating:** Electro zinc plated, min. 5 µm
- **Temperature range:** -30 °C to +120 °C

PROPERTIES - SBS

- **Material:** Steel DD 11 (material no. 1.0332) acc. to DIN EN 10111 / PA
- **Zinc plating:** Electro zinc plated, min. 5 µm
- **Adhesion friction factor:** 0.25 - 0.30
- **Sliding friction factor:** 0.16 - 0.18
- **Temperature range:** -40 °C to +100 °C

APPROVALS - SBS



TECHNICAL DATA

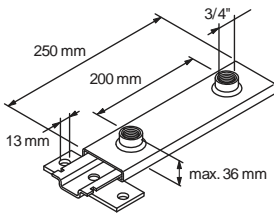

GLL 3/4"

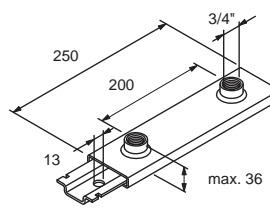

GL 3/4"

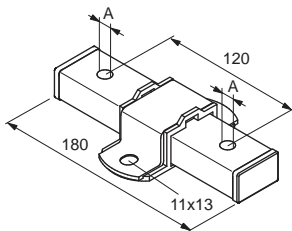
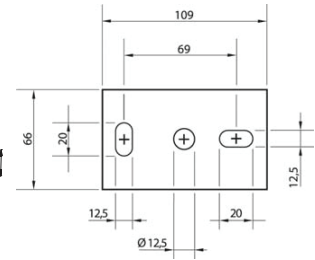
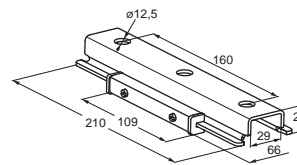

SBS

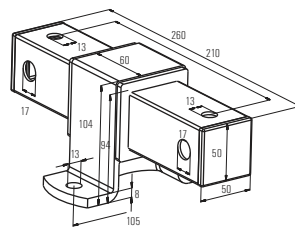

SBS 12/16

Item	Art.-NO.	Sales unit (pcs)
GLL 3/4"	064038	5
GL 3/4"	064041	5
FSC 1	507866	12

Item	Art.-NO.	Thread A	Sales unit (pcs)
SBS M 8	079685	M 8	8
SBS M 10	079686	M 10	8
SBS 12 / 16	047726	M 12 / 16	1

Item	Art.-NO.	Recommended suspended		Recommended vertical	
		N _{rec} (kN)	N _d (kN)	N _{rec} (kN)	N _d (kN)
GLL 3/4"	064038	3.50	4.90	4.00	5.56
GL 3/4"	064041	3.50	4.90	4.00	5.56
FSC 1	507866	1.30	1.82	1.00	1.40
SBS M 8	079685	1.50	2.10	1.50	2.10
SBS M 10	079686	1.50	2.10	1.50	2.10
SBS 12 / 16	047726	7.80	10.92	7.80	10.92

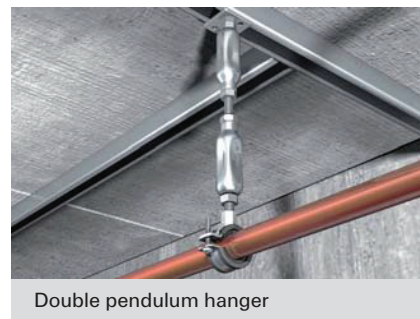
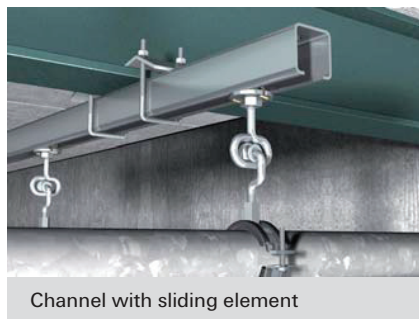

PROPERTIES

- **Material:** Steel DD11 (material no. 1.0332) acc. to DIN EN 10111
- **Zinc plating:** Electro zinc plated, min. 3 µm
Electro zinc plated, min. 5 µm

TECHNICAL DATA

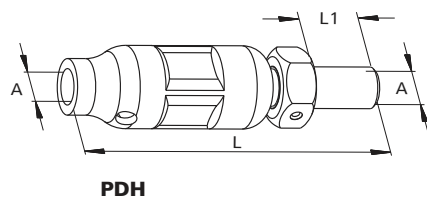
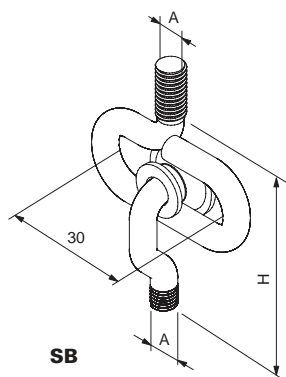

Item	Art.-NO.	Thread A1	Height H (mm)	Sales unit (pcs)
SB M 8	079680	M 8	75	25
SB M 10	079681	M 10	90	25

Item	Art.-NO.	Thread A1	Length L (mm)	Length L1 (mm)	Sales unit (pcs)
PDH K M 8	068267	M 8	50	18	50
PDH K M 10	068269	M 10	54	18	50
PDH M 8	079676	M 8	76	18	50
PDH M 10	079677	M 10	80	18	50
PDH M 12	064037	M 12	90	20	25

Item	Art.-NO.	Recommended load N_{rec} (kN)	Design load N_d (kN)
SB M 8	079680	0.40	0.56
SB M 10	079681	0.65	0.91
PDH K M 8	068267	2.40	3.36
PDH K M 10	068269	3.00	4.20
PDH M 8	079676	2.40	3.36
PDH M 10	079677	3.00	4.20
PDH M 12	064037	3.50	4.90



Spiral airduct on cantilever

PROPERTIES

- **Material:** Steel DX5 1D+Z 275 MA-C (material no. 1.0226+Z) acc. to DIN EN 10327
- **Zinc plating:** sendzimir-galvanised, app. 15 µm
- **Connecting nut:** resistance welded domed nut, M8 / M 10, SW 13
- **Locking screw:** Oval head screw with combination recessed head.
- **Material sound insulation insert:** SBR/EPDM; chlorine-free; silicone-free
- **Sound insulation:** For DIN 4109
- **Temperature range:** 50 °C to +100 °C
- **Hardness:** 45 ± 5 °C Shor A
- **Fire behaviour:** DIN 4102: Class B2

INSTALLATION

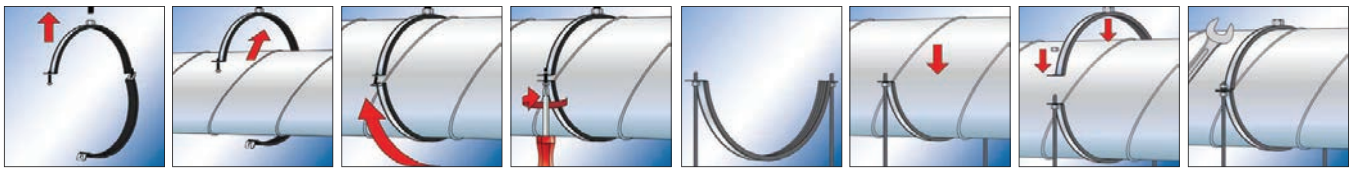

TECHNICAL DATA

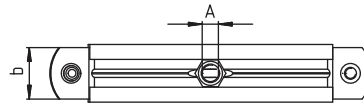
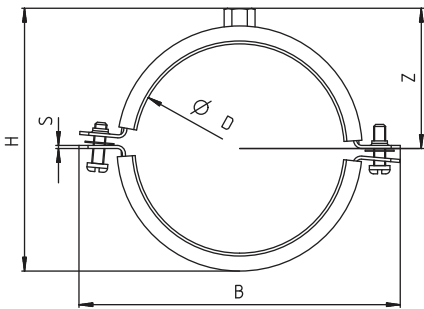

Item	Art.-NO.	Thread A	Clamping range D (mm)	Height H H (mm)	Width B B (mm)	b x s (mm)	Hight Z Z (mm)	Locking Screw	Recommended load N _{rec} (kN)	Design load N _d (kN)	Sales unit (pcs)
LGS 80	079491	M 8/M 10	80	110	134	25 x 1.25	62	M 6	0.6	0.84	25
LGS 90	079492	M 8/M 10	90	120	144	25 x 1.25	67	M 6	0.6	0.84	25
LGS 100	079493	M 8/M 10	100	131	155	25 x 1.25	72	M 6	0.6	0.84	20
LGS 112	079494	M 8/M 10	112	143	167	25 x 1.25	78	M 6	0.6	0.84	20
LGS 125	079495	M 8/M 10	125	156	180	25 x 1.25	85	M 6	0.6	0.84	10
LGS 140	079496	M 8/M 10	140	171	195	25 x 1.25	92	M 6	0.6	0.84	10
LGS 150	079497	M 8/M 10	150	181	205	25 x 1.25	97	M 6	0.6	0.84	10
LGS 160	079498	M 8/M 10	160	191	215	25 x 1.25	102	M 6	0.6	0.84	10
LGS 180	079499	M 8/M 10	180	211	235	25 x 1.25	112	M 6	0.6	0.84	10
LGS 200	079500	M 8/M 10	200	231	255	25 x 1.25	122	M 6	0.6	0.84	15
LGS 224	079501	M 8/M 10	224	255	279	25 x 1.5	134	M 6	0.6	0.84	15
LGS 250	079502	M 8/M 10	250	281	305	25 x 1.5	147	M 6	0.6	0.84	10
LGS 280	079503	M 8/M 10	280	311	335	25 x 1.5	162	M 6	0.6	0.84	10
LGS 300	079504	M 8/M 10	300	331	356	25 x 1.5	172	M 6	0.6	0.84	10
LGS 315	079505	M 8/M 10	315	347	371	25 x 1.5	180	M 6	0.6	0.84	10
LGS 355	079506	M 8/M 10	355	387	411	25 x 1.5	200	M 6	0.6	0.84	10
LGS 400	079507	M 8/M 10	400	431	356	25 x 1.5	222	M 6	0.6	0.84	10
LGS 450	024637 ⁽¹⁾	M 8/M 10	450	485	524	25 x 2.5	247	M 10	0.8	1.12	1
LGS 500	024638 ⁽¹⁾	M 8/M 10	500	535	574	25 x 2.5	272	M 10	0.8	1.12	1
LGS 560	024639 ⁽¹⁾	M 8/M 10	560	595	634	25 x 2.5	302	M 10	0.8	1.12	1
LGS 600	024640 ⁽¹⁾	M 8/M 10	600	635	674	25 x 2.5	322	M 10	0.8	1.12	1
LGS 630	024641 ⁽¹⁾	M 8/M 10	630	665	705	25 x 3.0	338	M 10	0.8	1.12	1
LGS 710	024642 ⁽¹⁾	M 8/M 10	710	745	785	25 x 3.0	378	M 10	0.8	1.12	1
LGS 800	024643 ⁽¹⁾	M 8/M 10	800	835	875	25 x 3.0	423	M 10	0.8	1.12	1
LGS 900	024644 ⁽¹⁾	M 8/M 10	900	935	975	25 x 3.0	473	M 10	0.8	1.12	1
LGS 1000	024645 ⁽¹⁾	M 8/M 10	1000	1035	1075	25 x 3.0	523	M 10	0.8	1.12	1
LGS 1120	024646 ⁽¹⁾	M 8/M 10	1120	1155	1195	25 x 3.0	583	M 10	0.8	1.12	1
LGS 1250	024647 ⁽¹⁾	M 8/M 10	1250	1285	1326	25 x 3.0	648	M 10	0.8	1.12	1

(1) The installation with two threaded rods allows to double the given recommended loads.

Textile web strapping **GWB** / Perforated steel banding **LBV** / **LBK**

GWB



LPV LPK



PROPERTIES

- **Material:** Polypropylene (GWB)
Steel DX5 1D+Z (material no. 1.0226)
acc. to DIN EN 10327
- **Zinc plating:** Electro zinc plated, min. 7 µm
Protective coating LBK: PE

ADVANTAGES

- The perforated tapes' material thicknesses and plastic covering allows the tapes to be easily cut to size using metal shears.
- The perforated tapes' hole geometry enables concrete fixing using the impact nail
- Pipe fastening using textile tape allows for cheap and simple installation
- The textile tape roll allows the correct tape length to be chosen to suit the diameter in question
- Hangings with textile tape are a fast solution for temporary fixings

INSTALLATION

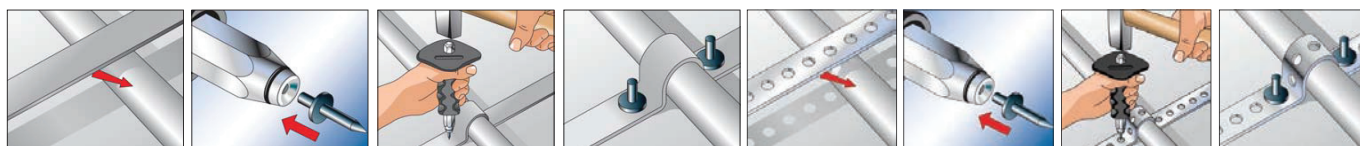

TECHNICAL DATA

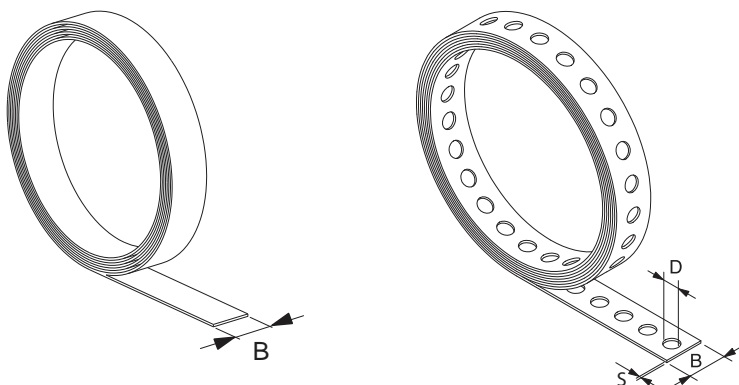

Item	Art.-NO.	Total length l (mm)	Width B B (mm)	Thickness S (mm)	Sales unit (pcs)
GWB	020959	10.000	15	1.1	10

Item	Art.-NO.	Total length l (mm)	Width B B (mm)	Thickness S (mm)	Eye Ø D (mm)	Sales unit (pcs)
LBV 12	079549	10.000	12	0.75	6	10
LBV 17	079550	10.000	17	0.75	6.5	10
LBV 25	079551	10.000	25	0.88	8.5	8
LBK 14	079553	10.000	14	2.6	5	10
LBK 19	079554	10.000	19	2.4	6.5	8
LBK 27	079555	10.000	27	2.4	8.5	5

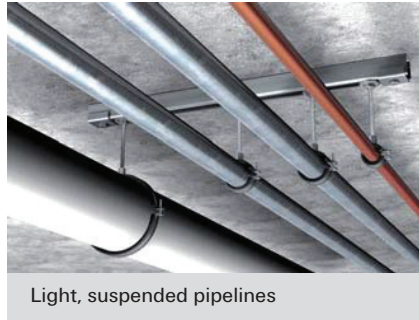

Light, suspended pipelines

PROPERTIES

- **Material:** Steel DX5 1D+Z 275 MA-C (material no. 1.0226+Z) acc. to DIN EN 10327 / ASTM A653
- **Zinc plating:** sendzimir zinc plated, approx. 20 µm
- **Material A2:** Stainless steel of the corrosion resistance class II, e.g. A2

TECHNICAL DATA

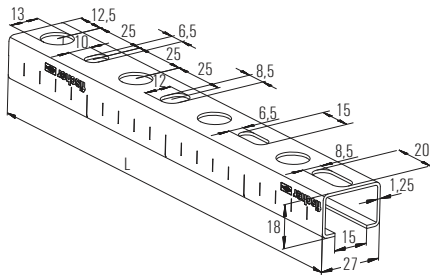

MS 27/18

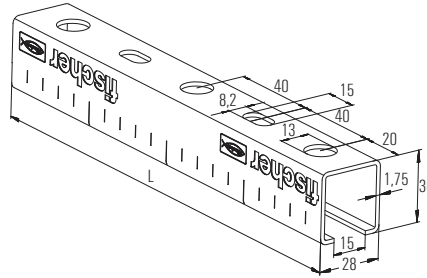

MS 28/30

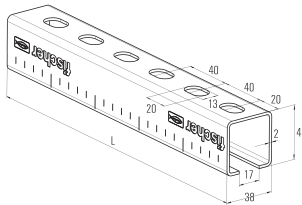

MS 38/40

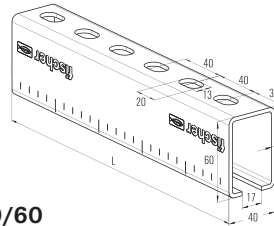

MS 40/60

Item	Art.-NO.	Sales unite (pcs.)	Length L (mm)	Item	Art.-NO.	Sales unite (pcs.)	Length L (mm)
MS 27/18/1.25 - 2 m	079560	1	2000	MS 27/18/1.25 - 3 m	079557	3000	3000
MS 27/18/1.25 - 6 m	030072	1	6000	MS 28/30/1.75 - 2 m	079561	2000	2000
MS 28/30/1.75 - 3 m	079558	1	3000	MS 28/30/1.75 - 2 m	079562	2000	2000
MS 38/40/2.00 - 3 m	079559	1	3000	MS 38/40/2.00 - 4 m	093281	4000	4000
MS 38/40/2.00 - 6 m	030075	1	6000	MS 40/60/3.00 - 6 m	014314	6000	6000
MS 27/18 A2 - 2 m	67905	1	2000	-	-	-	-

LOADS

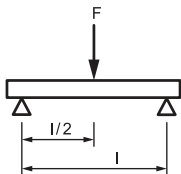

Item	Weight W (kg/m)	Area A (mm ²)	Moment of inertia I _y (mm ⁴)	Moment of inertia I _z (mm ⁴)	Section modulus W _y (mm ³)	Section modulus W _z (mm ³)	Max. recommended static load				
							Length = .5 M	Length = .1 M	Length = 1.5 M	Length = 2 M	Length = 3 M
							Frec (kN)	Frec (kN)	Frec (kN)	Frec (kN)	Frec (kN)
MS 27/18/1.25	0.66	84	3600	9600	340	710	0.44	0.18	0.08	0.05	0.02
MS 28/30/1.75	1.25	259	17700	20900	1020	1490	1.31	0.65	0.40	0.22	0.10
MS 38/40/2.00	2	255	53900	61800	2400	3250	3.09	1.55	1.03	0.68	0.30
MS 40/60/3.00	3.91	498	215600	135400	6580	6770	8.53	4.26	1.84	2.13	1.21

(1) Maximum permissible deflection under load = L/200
 (2) load safety factor 1.4 is included



ALK

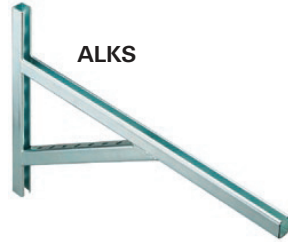

ALKS

PROPERTIES

- **Material:** Base plate: Steel DC01 (material no. 1.0330) acc. to DIN EN 10111
Channel: steel S235JR (material no. 1.0037) acc. to DIN EN 10025
- **Zinc plating:** Electro zinc plated, min. 13 µm
- **Material A2:** Stainless steel of the corrosion resistance class II, e.g. A2

TECHNICAL DATA

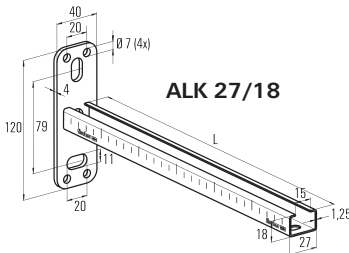

ALK 27/18

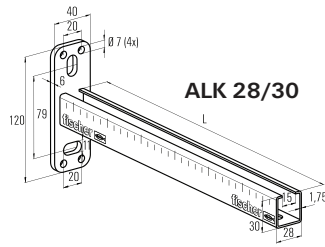

ALK 28/30

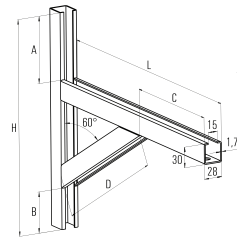

ALKS

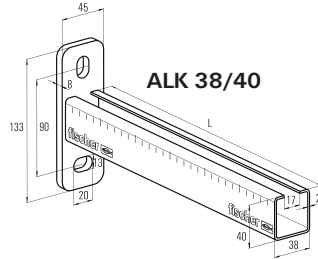

ALK 38/40

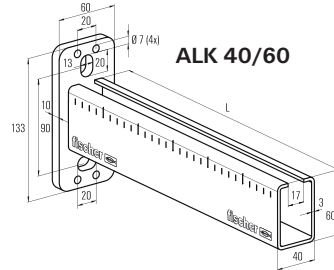

ALK 40/60

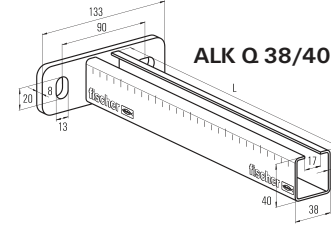

ALK Q 38/40

Item	Art.-NO.	Qty. per box (pcs.)	Profile	Length L (mm)	Item	Art.-NO.	Qty. per box (pcs.)	Profile	Length L (mm)
Cantilever arm ALK									
ALK 27/18 - 200	079575	20	27/18	200	ALK 27/18 - 300	079576	20	27/18	300
ALK 28/30 - 200	079577	10	28/30	200	ALK 28/30 - 320	079578	10	28/30	320
ALK 28/30 - 440	079579	10	28/30	440	ALK 38/40 - 200	079580	10	38/40	200
ALK 38/40 - 360	079581	10	38/40	360	ALK 38/40 - 440	063560	10	38/40	440
ALK 38/40 - 520	079582	10	38/40	520	ALK 38/40 - 600	020929	10	38/40	600
ALK 38/40 - 800	040399	1	38/40	800	ALK 38/40 - 1000	040400	1	38/40	1000
ALK 40/60 - 600	063561	5	40/60	600	ALK 40/60 - 800	063562	1	40/60	800
ALK 40/60 - 1000	063563	1	40/60	1000	ALK Q 38/40 - 440	040401	10	38/40	440
ALK Q 38/40 - 600	040402	10	38/40	600	ALK 27/18 - 200 A2	65101	20	-	200

Cantilever arm ALKS

Item	Art.-NO.	Qty. per box (pcs.)	Profile	Length H (mm)	Length L (mm)	Height A (mm)	Height B (mm)	Length C (mm)	Length D (mm)
ALKS 28/30 - 400	063581	5	28/30	315	400	98	60	180	254
ALKS 28/30 - 600	063594	5	28/30	400	600	100	70	254	400

LOADS

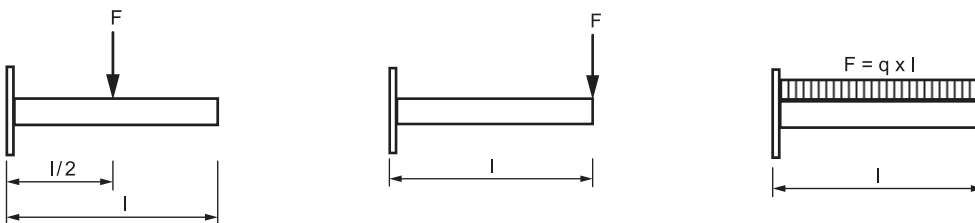

Item	Art.No.	Max. recommended static load			Item	Art.No.	Max. recommended static load		
		Load case 1 Frec (kN)	Load case 2 Frec (kN)	Load case 3 Frec (kN)			Load case 1 Frec (kN)	Load case 2 Frec (kN)	Load case 3 Frec (kN)
ALK 38/40 - 200	079580	3.75	1.88	3.75	ALK 38/40 - 360	079581	2.2	1.1	2.2
ALK 38/40 - 440	063560	1.7	0.85	1.7	ALK 38/40 - 520	079582	1.4	0.7	1.4
ALK 38/40 - 600	020929	1.25	0.63	1.25	ALK 38/40 - 800	040399	0.94	0.35	0.94
ALK 38/40 - 1000	040400	0.6	0.23	0.6	ALK 40/60 - 600	063561	3.5	1.75	3.5
ALK 40/60 - 800	063562	2.63	1.31	2.63	ALK 40/60 - 1000	063563	2.1	0.91	2.1
ALK 27/18 - 200	079575	0.54	0.27	0.54	ALK 27/18 - 300	079576	0.36	0.17	0.36
ALK 28/30 - 200	079577	1.63	0.82	1.63	ALK 28/30 - 320	079578	1.08	0.54	1.08
ALK 28/30 - 440	079579	0.8	0.4	0.8	ALKS 28/30 - 400	063581	5	1.3	5
ALKS 28/30 - 600	063594	5	0.9	5	-	-	-	-	-

(1) Maximum permissible deflection under load = $L/180$
 (2) load safety factor 1.4 is included

Saddle flange SF

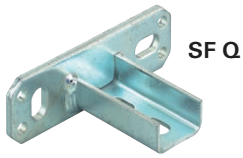

PROPERTIES

- **Material:** Steel DD11(material no. 1.0332) acc. to DIN EN 10111
- **Zinc plating:** Electro zinc plated, min. 8µm
- **Material A2:** Steel DC01 – min. 340 (material no. 1.0037) acc. to DIN EN 10139
- **Zinc plating:** Electro zinc plated, min. 8µm
- **Material A2:** Stainless steel of the corrosion resistance class II, e.g. A2

TECHNICAL DATA

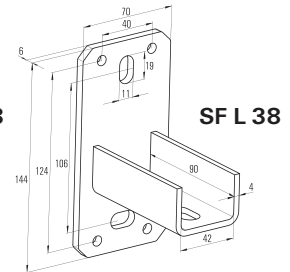
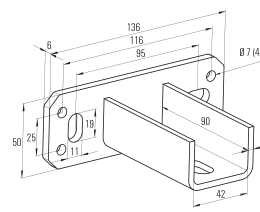
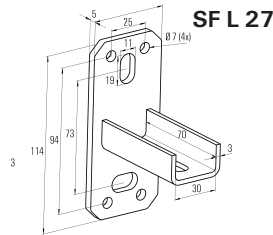
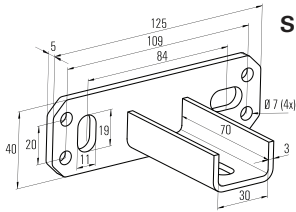

Item	Art.-NO.	Qty.per box (pcs.)	Version	Material
SF Q 27	079409	15	horizontal	Material 1
SF L 27	079585	15	vertical	Material 1
SF Q 38	079410	10	horizontal	Material 2
SF L 38	079586	8	vertical	Material 2
SF L 27 A2	77615	15	vertical	Material 3

Installation angle bracket MW



PROPERTIES

- **Material:** Steel S235 JR (material no. 1.0332) acc. to DIN EN 10025
- **Zinc plating:** Electro zinc plated, min. 8µm
- **Material A2:** Stainless steel of the corrosion resistance class II, e.g. A2

TECHNICAL DATA

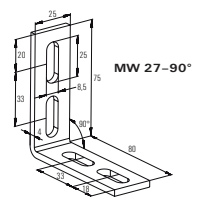
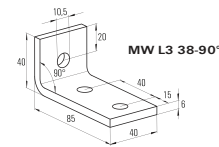
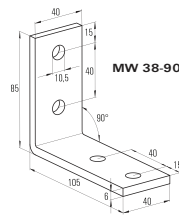
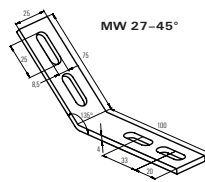
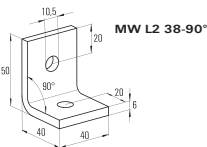
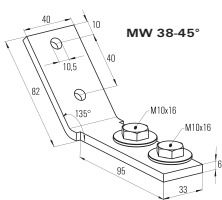

Item	Art.-NO.	Qty.per box (pcs.)	Angle
MW 38 - 45°	079658	10	45°
MW 38 - 90°	079657	20	90°
MW L 2 38 - 90°	063599	20	90°
MW L 3 38 - 90°	063597	20	90°
MW 27 - 45°	079656	25	-
MW 27 - 90°	079655	25	-
MW 27 - 45° A2	77626	25	-
MW 27 - 90° A2	77625	25	-



Assembly of channel connector

PROPERTIES

- **Material:** Base plate: Steel DC01 (material no. 1.0330) acc. to DIN EN 10130
- **Zinc plating:** Electro zinc plated, 5 µm
- **Material SV 38/SV 27:** Steel DC01 (material no. 1.0330) acc. to DIN EN 10130
- **Material SV 40:** S235JR (material no. 1.0037) acc. to DIN EN 10025
- **Zinc plating:** Electro zinc plated, 5 µm

TECHNICAL DATA

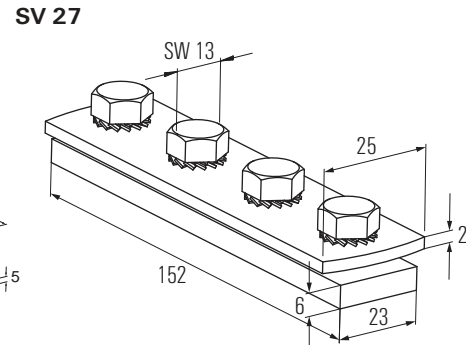
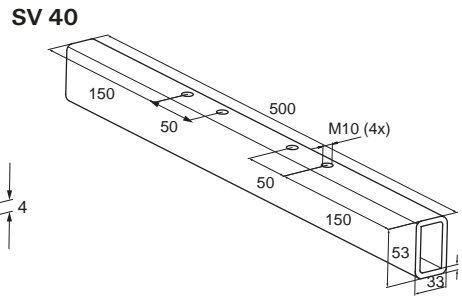
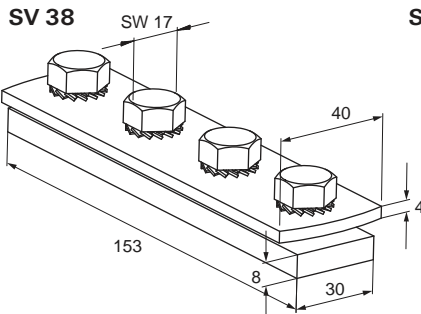

Item	Art.-NO.	Qty. per box (pcs.)	For channel
SV 27	079660	20	27/18 + 28/30
SV 38	079661	10	38/40
SV 40	063643	1	40/60 + 40/120

Channel connector FUF OC and PFUF OC



Connector for installation grid

PROPERTIES

- **Material FUF OC:** Steel S235 JR (material no. 1.0037) acc. to DIN EN10025
- **Zinc plating FUF OC:** Electro zinc plated, min. 5 µm
- **Material PFUF OC:** Steel DD11 (material no. 1.0332) acc. to DIN EN 10111
- **Zinc plating PFUF OC:** Electro zinc plated acc. DIN 50979, min. 8 µm

ADVANTAGES/BENEFITS

- The FUF OC connector in combination with FCN Clix P allows a simple and time-saving installation.
- The PFUF OC connector in combination with PFCN allows a simple and time-saving installation.

TECHNICAL DATA

FUF OC 41

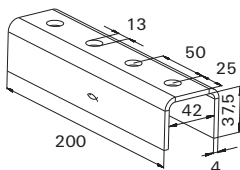

FUF OC 62

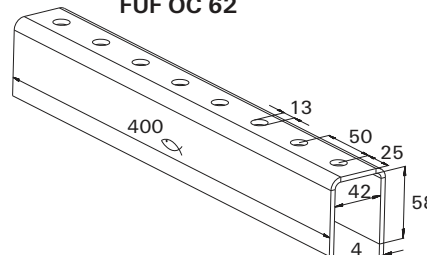

PFUF OC

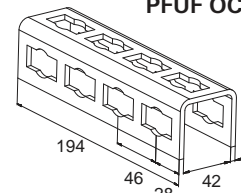

Item	Art.-NO.	Length (mm)	Sales Unit (pcs.)
FUF OC 41	504517	200	20
FUF OC 62	504518	400	10
PFUF OC	533743	194	6



PROPERTIES

- **Material:** Steel S235 JR (material no. 1.0037) acc. to DINEN10025
- **Zinc plating:** Electro zinc plated, min. 5 µm

TECHNICAL DATA

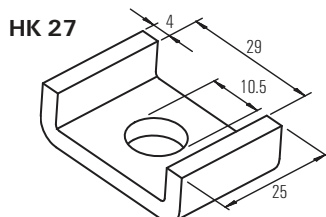
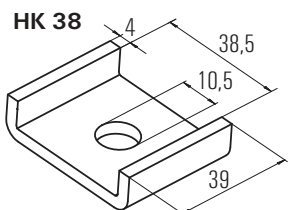

Item	Art.-NO.	Qty. per box (pcs.)	For channel M
HK 38	079651	50	MS 38/40
HK 27	079650	50	MSL 27 / 18 - MS 28 / 30

Channel nut HG, SM



HG 27



HG 38



SM

PROPERTIES

- **Material:** Steel S235 JR (material no. 1.0037) acc. to DINEN10025
- **Zinc plating:** Electro zinc plated, min. 5 µm
- **Material A2:** Stainless steel of the corrosion resistance class II, e.g. A2

TECHNICAL DATA

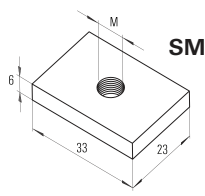
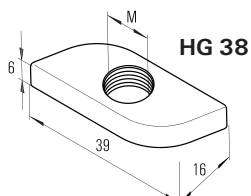
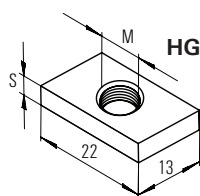

Item	Art.-NO.	Qty. per box (pcs.)	Thread M	Thickness S (mm)	For channel
HG 27 M 6	049480	200	M 6	4	27/18 - 28/30
HG 27 M 8	079595	100	M 8	5	27/18 - 28/30
HG 27 M 10	079596	100	M 10	5	27/18 - 28/30
HG 38 M 6	077667	100	M 6	-	38/40 - 40/60
HG 38 M 8	024687	100	M 8	-	38/40 - 40/60
HG 38 M 10	024688	100	M 10	-	38/40 - 40/60
SM 38 M 8	079600	50	M 8	-	38/40 - 40/60
SM 38 M 10	079601	50	M 10	-	38/40 - 40/60
HG 27 M 8 A2	77636	100	M 8	4	27/18 A2
HG 27 M 10 A2	64977	100	M 10	4	27/18 A2

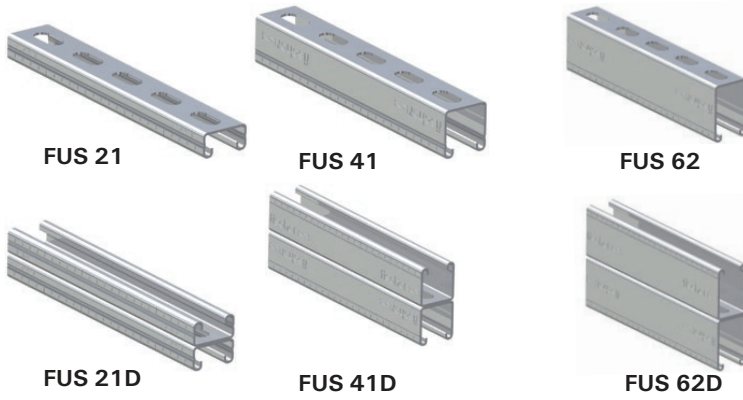

PROPERTIES

- **Material:** Steel S250 GD-C (material no. 1.0242+Z) acc. to DIN EN 1.0346
- **Zinc plating:** Sendzimir zinc plated, approx. 20 µm
- **Material HDG:** Steel S235 JR (material no. 1.0045) acc. to EN 10027-2
- **Zinc plating:** Hot-dip galvanized, approx. 40 µm acc. to DIN EN ISO 1461
- **Material A2:** Stainless steel of the corrosion resistance class II, e.g. A2
- **Material A4:** Stainless steel of the corrosion resistance class III, e.g. A4

APPROVALS



TECHNICAL DATA

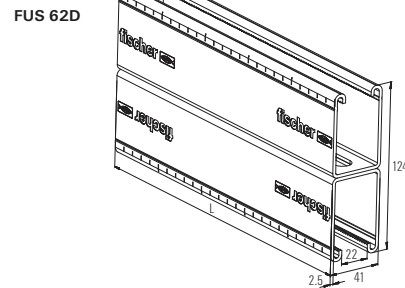
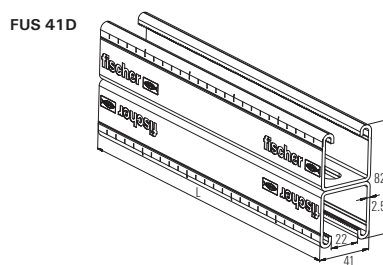
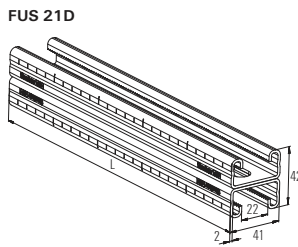
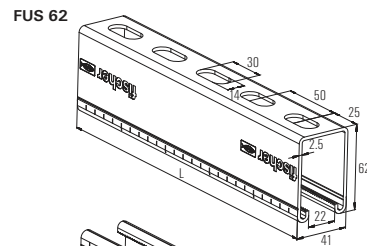
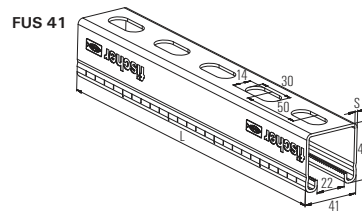
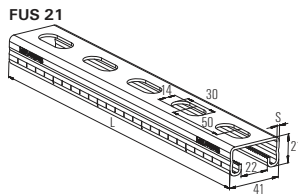

Item	Art.-NO.	Qty. per box (pcs.)	Length L (m)	Thickness S (mm)
FUS 21/2.0 - 2 m	40391	1	2	2.0
FUS 21/2.0 - 3 m	97660	1	3	2.0
FUS 21/2.5 - 3 m	77349	1	3	2.5
FUS 21/2.5 - 6 m	77541	1	6	2.5
FUS 41/2.0 - 2 m	40390	1	2	2.0
FUS 41/2.0 - 3 m	97658	1	3	2.0
FUS 41/2.0 - 6 m	97659	1	6	2.0
FUS 41/2.5 - 2 m	92295	1	2	2.5
FUS 41/2.5 - 3 m	77347	1	3	2.5
FUS 41/2.5 - 6 m	77537	1	6	2.5
FUS 62/2.5 - 6 m	504457	1	6	2.5
FUS 21D/2.0 - 3 m	504458	1	3	2.0

Item	Art.-NO.	Qty. per box (pcs.)	Length L (m)	Thickness S (mm)
FUS 41D/2.5 - 6 m	504459	1	6	2.5
FUS 62D/2.5 - 6 m	504460	1	6	2.5
FUS 41/2.0 - 3 m hdg.	517426	1	3	2.0
FUS 62/2.5 - 3 m hdg.	517427	1	3	2.5
FUS 62/2.5 - 6 m hdg.	517428	1	6	2.5
FUS 21/2.0 A2 - 2m	504466	1	2	2.0
FUS 41/2.0 A2 - 2m	504468	1	2	2.0
FUS 41/2.5 A2 - 2m	504470	1	2	2.5
FUS 21/2.0 A4 - 2m	504472	1	2	2.0
FUS 41/2.0 A4 - 2m	504474	1	2	2.2
FUS 41/2.5 A4 - 2m	504475	1	2	2.5

LOADS

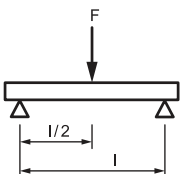

Item	Weight W (kg/m)	Area A (mm²)	Moment of inertia I _y (mm⁴)	Moment of inertia I _z (mm⁴)	Section modulus W _y (mm³)	Section modulus W _z (mm³)	Max. recommended static load				
							Length = .5 M	Length = .1 M	Length = 1.5 M	Length = 2 M	Length = 3 M
							Frec (kN)	Frec (kN)	Frec (kN)	Frec (kN)	Frec (kN)
FUS 21/2.0	1.44	172	9700	46600	890	2270	1.14	0.49	0.22	0.12	0.05
FUS 21/2.5	1.67	199	10300	52800	930	2580	1.19	0.52	0.23	0.13	0.06
FUS 41/2	2.06	252	53300	76900	2580	3750	3.30	1.65	1.10	0.67	0.30
FUS 41/2.5	2.45	300	60000	89900	2850	4380	3.65	1.82	1.22	0.76	0.34
FUS 62/2.5	3.27	405	177000	129000	5620	6290	7.19	3.60	2.40	1.80	0.99
FUS 21D/2	2.87	344	54900	93100	2610	4540	3.34	1.67	1.11	0.69	0.31
FUS 41D/2.5	4.89	600	350100	179000	8760	8780	11.21	5.61	3.74	2.80	1.57
FUS 62D/2.5	6.55	809	1110000	258000	17900	12580	22.91	11.46	7.64	5.73	3.82

(1) Maximum permissible deflection under load = L/200
(2) load safety factor 1.4 is included



PROPERTIES

- **Material:** Base plate: Steel (material no. 1.0330), DC01 acc. DIN EN 10139, Channel: Steel S235 JR acc. DIN EN 10025, material no. 10037
- **Zinc plating:** Electro zinc plated, min. 13 µm
- **Material HDG:** Base plate: Steel DC01 (material no. 1.0330) acc. to DIN EN 10111 and DIN EN 10139, Channel: Steel S235 JR (material no. 10037) acc. to DIN EN 10025
- **Zinc plating:** Hot-dip galvanized, approx 40 µm acc. to DIN EN ISO 1461
- **Material A4:** Stainless steel of the corrosion resistance class III, e.g. A4

APPROVALS



TECHNICAL DATA

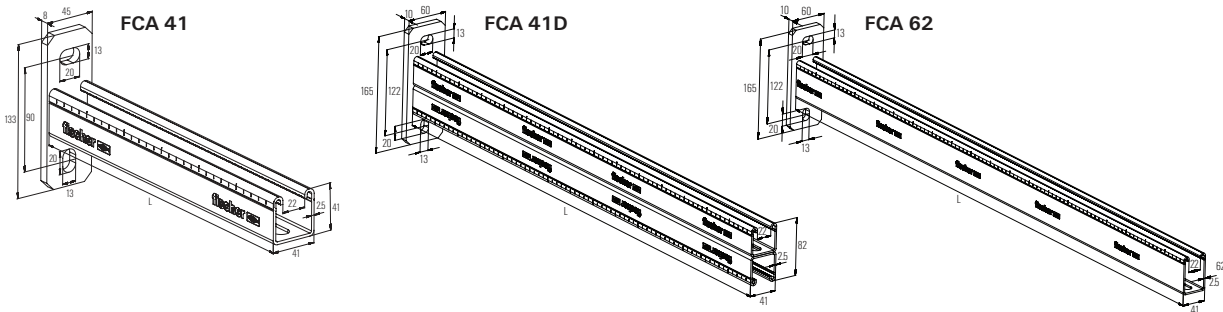

Item	Art.-NO.	Qty. per box (pcs.)	Profile	Weight (kg/m)	Item	Art.-NO.	Qty. per box (pcs.)	Profile	Length (kg/m)
FCA 300	077359	1	41/2.5	300	FCA 450	077361	1	41/2.5	450
FCA 600	077363	1	41/2.5	600	FCA 750	077365	1	41/2.5	750
FCA 62 - 1000	504315	1	62/2.5	1000	FCA 41D 750	504317	1	41D/2.5	750
FCA 41D 1000	504319	1	41D/2.5	1000	FCA 300 hdg.	517411	1	41/2.5	300
FCA 450 hdg.	517412	1	41/2.5	450	FCA 600 hdg.	517413	1	41/2.5	600
FCA 750 hdg.	517414	1	41/2.5	750	FCA 41 A4 - 300	505487	1	-	300
FCA 41 A4 - 450	505488	1	-	450	FCA 41 A4 - 600	505489	1	-	600

LOADS

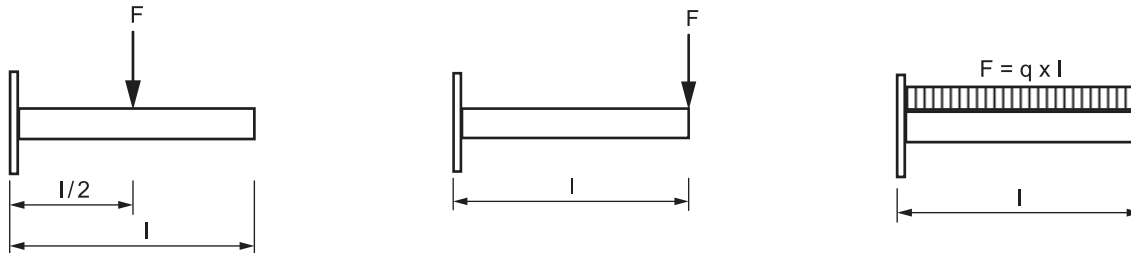

Item	Art.No.	Max. recommended static load		
		Load case 1 Frec (kN)	Load case 2 Frec (kN)	Load case 3 Frec (kN)
FCA 300	077359	2.67	1.3	2.67
FCA 450	077361	1.8	0.9	1.8
FCA 600	077363	1.33	0.67	1.33
FCA 750	077365	1.05	0.45	1.05
FCA 62 - 1000	504315	1.7	0.74	1.7
FCA 41D 750	504317	3.5	1.7	3.5
FCA 41D 1000	504319	2.6	1.3	2.6

(1) Maximum permissible deflection under load = $L/180$
(2) load safety factor 1.4 is included



PROPERTIES

- **Material:** Base plate: DC01 (steel 1.0330) acc. DIN EN 10139, Channel: S235JR (material no. 1.0037) acc. to DIN EN 10025
- **Zinc plating:** Electro zinc plated, min. 8 µm
- **Material:** Base plate: Steel DC01 (material no. 1.0330) acc. to DIN EN 10139, U profile: S235 JR (material no. 1.0037) acc. to DIN EN 10025
- **Zinc plating HDG:** Hot-dip galvanized, approx 40 µm acc. to DIN EN ISO 1461
- **Material A4:** Stainless steel of corrosion resistance class III, e.g. A4

TECHNICAL DATA

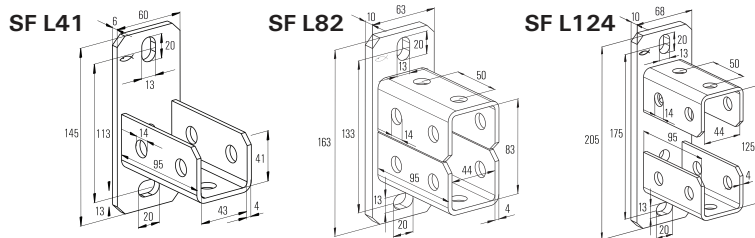

APPROVALS



Item	Art.-NO.	Qty. per box (pcs.)	For profile FUS
SF L 41	504355	10	21; 41; 21D; 62
SF L 82	504357	5	41D
SF L 124	504358	5	62D
SF L 41 hdg.	517421	10	21; 41; 21D; 62
SF L 41 A4	504522	10	FUS 21 + FUS 41

Angle fittings FAF

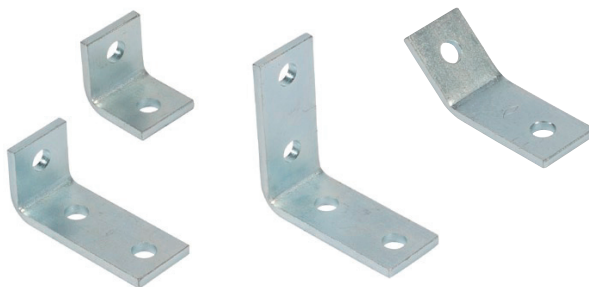

PROPERTIES

- **Material:** Steel DD11 (material no. 1.0332) acc. to DIN EN 10111
- **Zinc plating:** Electro zinc plated, min. 5 µm
- **Material A4:** Stainless steel of the corrosion resistance class III, e.g. A4

TECHNICAL DATA

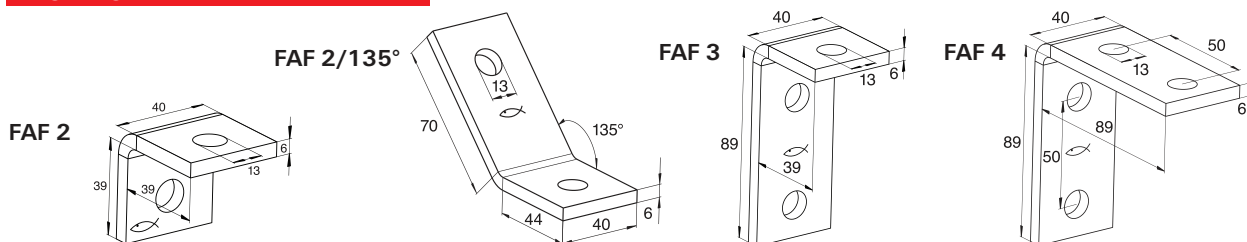

Item	Art.No.	Qty. per box (pcs.)
FAF 2 - angle fittings	504501	25
FAF 3 - angle fittings	504506	25
FAF 4 - angle fittings	504509	25
FAF 2/135° - angle fittings	504369	25
FAF 2 A4	504519	25
FAF 4 A4	504520	25
FAF 2/135° A4	504521	25

FUS 3D flanges FZF, FUF

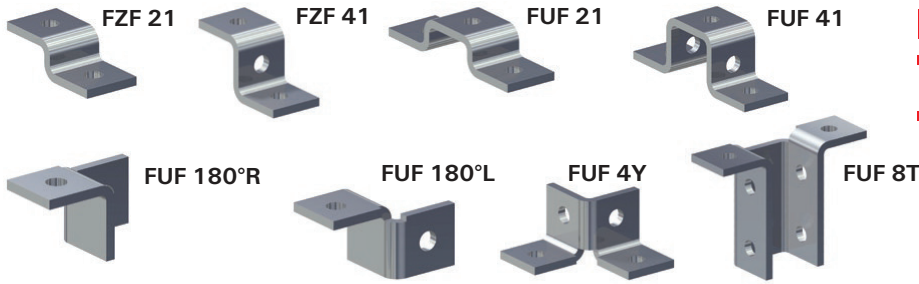

- PROPERTIES**
- **Material:** Steel DD11 (material no. 1.0332) acc. to DINEN10111
 - **Zinc plating:** Electro zinc plated, min. 5 µm

TECHNICAL DATA

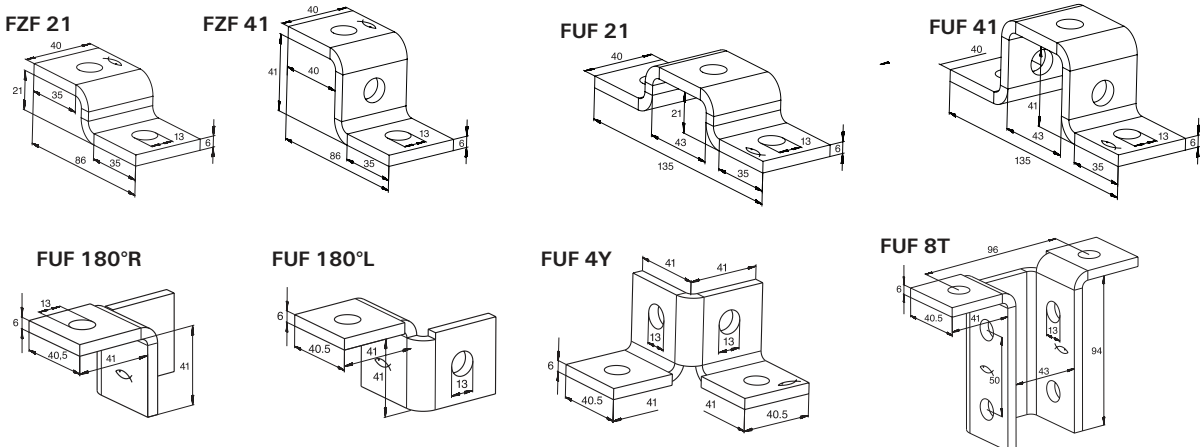

Item	Art.No.	Qty. per box (pcs.)	Type	Art.No.	Qty. per box (pcs.)
FZF 21	504375	25	FUF 4Y	504378	20
FZF 41	504515	25	FUF 180°L	504379	20
FUF 21	504376	25	FUF 180°R	504383	20
FUF 41	504377	25	FUF 8T	504387	10

Flat fittings FFF

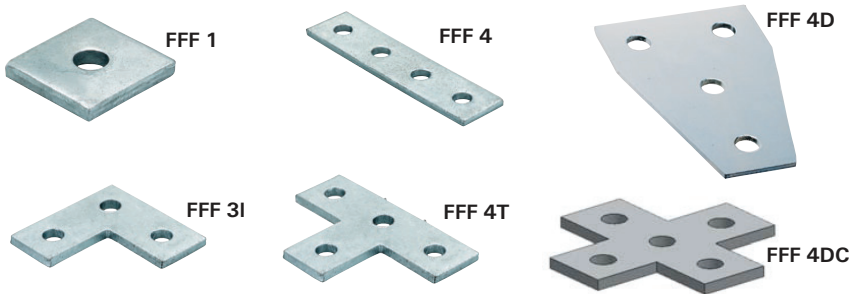

- PROPERTIES**
- **Material:** Steel DD11 (material no. 1.0332) acc. to DINEN10111
 - **Zinc plating:** Electro zinc plated, min. 5 µm

TECHNICAL DATA

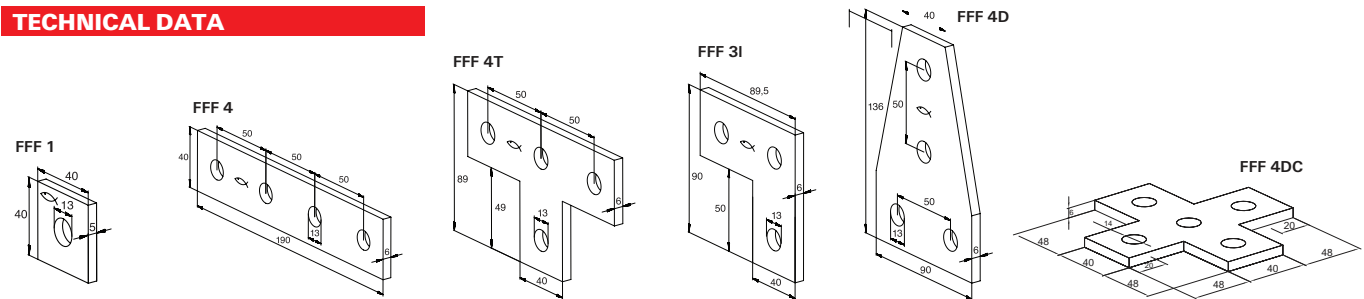

Item	Art.No.	Qty. per box (pcs.)
FFF 1 - Flat fitting	504494	25
FFF 3 L - Flat fitting	504498	25
FFF 4 I - Flat fitting	504499	25
FFF 4 T - Flat fitting	504500	25
FFF 4 D - Flat fitting	504368	25
FFF 4 DC - Flat fitting	550162	18

Variable bracket VB / Bracket FSB 45°



PROPERTIES

- **Material:** Steel DD11 (material no. 1.0332) acc. to DIN EN10111
- **Zinc plating:** Electro zinc plated, min. 5 µm

PROPERTIES

- **Material:** Steel DD11 (material no. 1.0332) acc. to DINEN10111
- **Zinc plating:** Electro zinc plated, min. 5 µm

TECHNICAL DATA

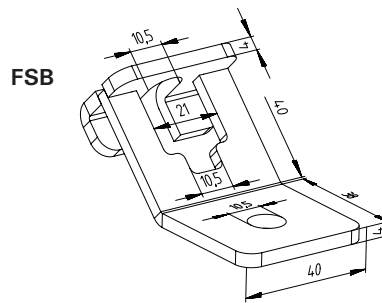
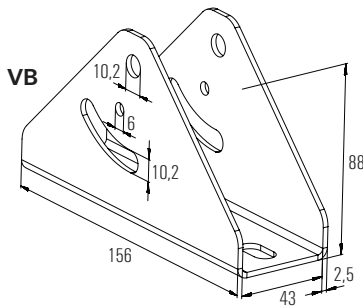

Type	Art.No.	Qty. per box (pcs.)
FSB 45°	71269	20
VB	04850	4

LOADS

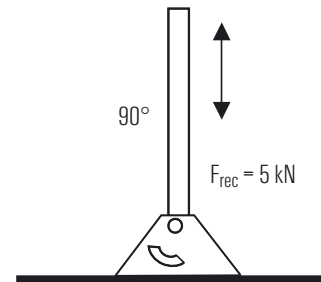
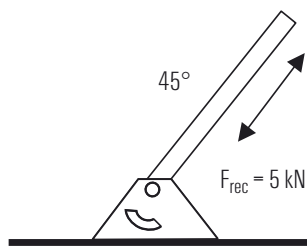
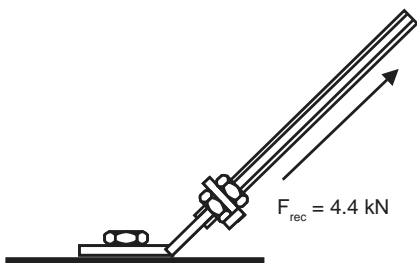

* load safety factor 1.4 is included

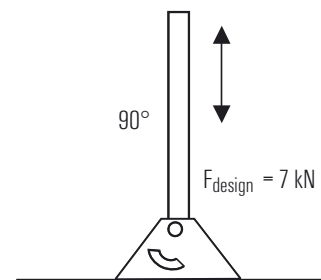
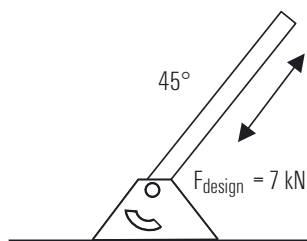
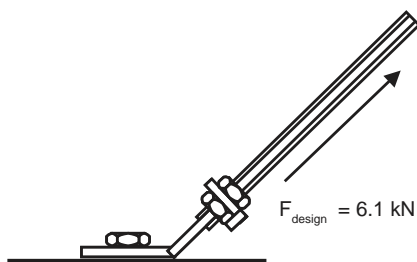



PROPERTIES

- **Material TKLS:** Steel HX420LAD+ZAD, material no. 1.0935, DIN EN 10346
- **Zinc plating:** Electro zinc plated, min. 7 µm
- **Material SS-TKLS:** Steel DX51D acc. to EN 10214, Material no.1.0226
- **Zinc plating:** Electro zinc plated, min. 5 µm

TECHNICAL DATA

TKLS

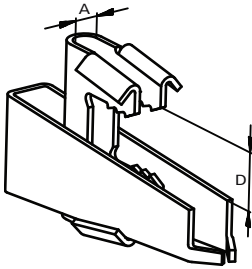

APPROVALS



Item	Art.-NO.	Hole diameter A (mm)	Clamping range D (mm)	Sales unit (pcs.)
TKLS Ø 9	531134	9	8 - 20	25
TKLS Ø 11	531136	11	8 - 20	25
TKLS Ø 13	531137	13	8 - 20	25
TKLS Ø 17	531138	17	11 - 26	16
SS-TKL M10/M12	048154	-	-	25

LOADS

Item	Art.-NO.	Recommended load N _{rec} (kN)	Design load N _d (kN)	Recommended. pipe-Ø acc. VDS CEA 4001
TKLS Ø 9	531134	2.00	2.80	> DN 50
TKLS Ø 11T	531136	3.50	4.90	> DN 50 ≤ DN 100
KLS Ø 13T	531137	5.00	7.00	> DN 100 ≤ DN 200
KLS Ø 17	531138	10.00	14.00	> DN 200 ≤ DN 250

Channel washer HK 41

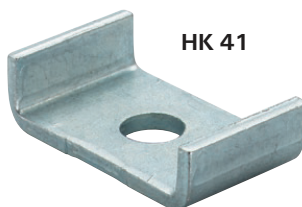

HK 41

PROPERTIES

- **Material:** Steel S235 JR (material no. 1.0037) acc. to DIN EN10025
- **Zinc plating:** Electro zinc plated, min. 8 µm
- **Material A4:** Stainless steel of the corrosion resistance class III, e.g. A4

TECHNICAL DATA

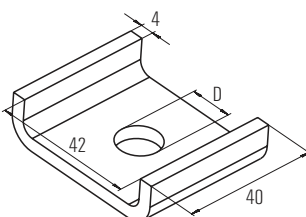

Item	Art.-NO.	Qty. per box (pcs.)	D (mm)
HK 41 8.5	504348	50	8.5
HK 41 10.5	504349	50	10.5
HK 41 12.5	504354	50	12.5
HK 41 12.5 - A4	504489	50	12.5

FCN Clix P



FCN Clix M

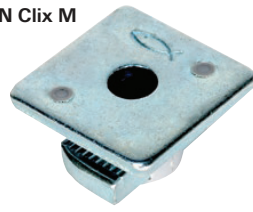

FCN



FCN-L



PROPERTIES

- **Material 1:** Steel S235 JR (material no. 1.0037) acc. DIN EN 10025, plastic nylon PA6
- **Zinc plating:** Electro zinc plated, min. 5 µm
- **Material 2 HDG:** Steel S235 JR (material no. 1.0037) acc. to DIN EN 10025
- **Zinc plating HDG:** Hot-dip galvanized, approx 40 µm acc. to DIN EN ISO 1461
- **Material A4:** Stainless steel of the corrosion resistance class III, e.g. A4
- **Plastic:** Nylon PA 6
- **Material:** ISO 898-1, DIN 975 & 976 (Steel: 4.8 & 8.8)
- **Finish FCN-L:** Electro galvanized (as per ASTM B633), Electro Galvanized (as per ASTM B633),
- **Material SS316:** DIN EN ISO 3506-1

TECHNICAL DATA

FCN

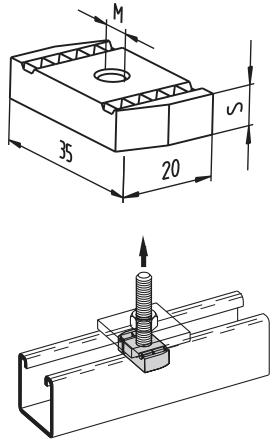

Spring nut tensile resistance

FCN Clix P

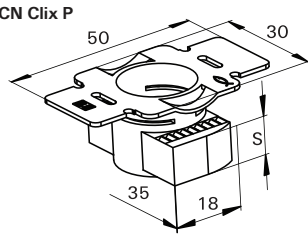

FCN Clix M

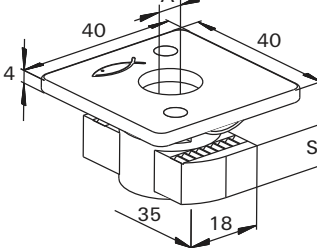

Spring nut shear resistance

Item	Art.-NO.	Qty. per box (pcs.)	Thread M	Thickness S (mm)	Max. tension load for FUS 2.0 mm		Max. tension load for FUS 2.5 mm		Max. shear load		Tightening torque for screw grade ≥ 8.8 Tinst (kN)
					Nrec (kN)	Ndesign (kN)	Nrec (kN)	Ndesign (kN)	Vrec (kN)	Vdesign (kN)	
FCN Clix P 6	504326	100	M 6	6	3.0	4.2	3.0	4.2	1.0	1.4	10
FCN Clix P 8	504327	100	M 8	6	4.0	5.6	4.0	5.6	2.0	2.8	20
FCN Clix P 10	504329	100	M 10	8	5.0	7.0	8.0	11.2	2.5	3.5	40
FCN Clix P 12	504331	100	M 12	9.5	5.0	7.0	8.0	11.2	3.0	4.2	50
FCN Clix M 6	504344	100	M 6	6	3.0	4.2	3.0	4.2	1.0	1.4	10
FCN Clix M 8	504345	100	M 8	6	4.0	5.6	4.0	5.6	2.0	2.8	20
FCN Clix M 10	504346	100	M 10	8	5.0	7.0	8.0	11.2	2.5	3.5	40
FCN Clix M 12	504347	100	M 12	9.5	5.0	7.0	8.0	11.2	3.0	4.2	50
FCN Clix P 12 HDG	517420	100	M 12	9.5	5.0	7.0	8.0	11.2	1.5	2.1	50
FCN Clix P 8 A4	504436	100	M 8	6	4.0	5.6	4.0	5.6	2.0	2.8	20
FCN Clix P 10 A4	504437	100	M 10	8	5.0	7.0	8.0	11.2	2.5	3.5	40
FCN Clix P 12 A4	504439	100	M 12	9.5	5.0	7.0	8.0	11.2	3.0	4.2	50
FCN Clix M 8 A4	504440	100	M 8	6	4.0	5.6	4.0	5.6	2.0	2.8	20
FCN Clix M 10 A4	504447	100	M 10	8	5.0	7.0	8.0	11.2	2.5	3.5	40
FCN 6	77405	100	M 6	6	3.0	4.2	3.0	4.2	1.0	1.4	10
FCN 8	77407	100	M 8	6	4.0	5.6	4.0	5.6	2.0	2.8	20
FCN 10	77409	100	M 10	8	5.0	7.0	8.0	11.2	2.5	3.5	40
FCN 12	77411	100	M 12	9	5.0	7.0	8.0	11.2	2.5	3.5	50

Item	Art.-NO. GI	Art.-NO. HDG	Art.-NO. SS316	Spring length (mm)	Thread D	Max. tension load for FUS 2.0 mm		Max. tension load for FUS 2.5 mm		Max. shear load		Tightening torque for screw grade ≥ 8.8 Tinst (kN)
						Nrec (kN)	Ndesign (kN)	Nrec (kN)	Ndesign (kN)	Vrec (kN)	Vdesign (kN)	
FCN-L6	516750	516765	516774	6	M 6	3.0	4.2	3.0	4.2	1.0	1.4	10
FCN-L8	516751	516766	516775	6	M 8	4.0	5.6	4.0	5.6	2.0	2.8	20
FCN-L10	516752	516767	516776	8	M 10	5.0	7.0	8.0	11.2	2.5	3.5	40
FCN-L12	516753	516768	-	9	M 12	5.0	7.0	8.0	11.2	2.5	3.5	50
FCN-L12	-	-	516777	9.2	M 12	5.0	7.0	8.0	11.2	2.5	3.5	50
FCN-L12	-	516769	-	12	M 12	5.0	7.0	8.0	11.2	2.5	3.5	50



Channel to steelbeam

PROPERTIES

- **Material:** Plate / U-bolt pipe hanger: Steel S235 JR (material no. 1.0037) acc. DINEN10025 Hexagon nut: Steel acc. ISO 898-2 resistance min. 4
- **Zinc plating:** Electro zinc plated, min. 5 µm
- **Material A4:** Stainless steel of the corrosion resistance class III, e.g. A4

TECHNICAL DATA

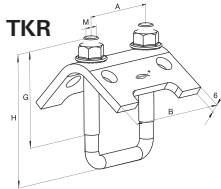

TKR 27/18

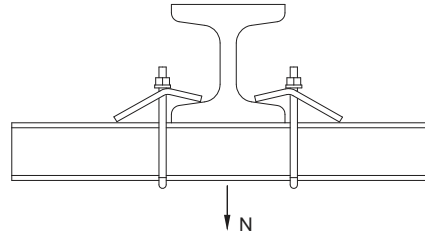
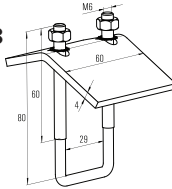

Item	Art.-NO.	Qty. per box (pcs.)	For profile	Width B (mm)	Hight H (mm)	Hight g (mm)	Thread M (mm)	Width A (mm)	Fixing thickness (mm)	Max. load(tension)	
										Nrecom (kN)	Ndesign (kN)
TKR 21 - 41	504363	20	MS 38/40 - FUS 21/41/21D	79	97	48	8	52	-	5.0	7.0
TKR 82	504366	20	MS 40/60 - FUS 62/41D	79	137	80	10	54	-	10.0	14.0
TKR 124	504367	10	MS 40/120 - FUS 62D	79	179	80	10	54	-	10.0	14.0
TKR 27/18	079411	25	27/18 + 28/30	-	-	-	-	-	0-29	2.8	3.9
TKR 21 - 41 A4	504476	20	FUS 21 - FUS 41	-	-	-	-	-	-	5.0	7.0

Clamp hanger TKL



Heavy drainage pipe on beam clamp

PROPERTIES

- **Material TKL:** TKL: Malleable cast iron EN-GJMB-350-10 acc. to DIN 1562 Bolt: Steel 8.8 acc. ISO 4017 Nut: Steel acc. ISO 4035, resistance min. 4
- **Material SS-TKL:** Steel DX51D acc. to EN 10214, material no. 1.0226
- **Zinc plating:** Electro zinc plated, min. 5 µm

APPROVALS



TECHNICAL DATA

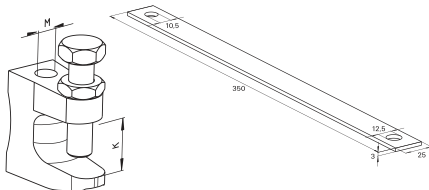

Item	Art.-NO.	Qty. per box (pcs.)	Clamping range K (mm)	EYE Ø D	Stamp on item	Max. load(tension)	
						Nrecom (kN)	Ndesign (kN)
TKL L M8	064055	50	0-18	M 8	TK M 8	1.2	1.6
TKL M8	079687	50	0-23	M 8	TK 10	2.5	3.5
TKL Ø 9	077605	50	0-18	9	TK N 8	1.2	1.6
TKL M10	079688	50	0-20	M 10	TK N 10	2.5	3.5
TKL Ø 11	079689	50	0-20	11	TK N 10	2.5	3.5
TKL M12	020949	50	0-26	M 12	TK 12	3.5	4.9
TKL Ø 13	043275	50	0-26	13	TK 12	3.5	4.9
SS-TKL M10/M12	048154	25	-	10/12	SS-TKR	-	-

* SS-TKL M 10/M 12 only require in case design according to VdS approval



WK



UW S



Suspended pipe under angle bracket

PROPERTIES - WK

- **Material:** Steel DD11 (material no. 1.0332) acc. to DIN EN10111
- **Zinc plating:** Electro zinc plated, min. 5 µm

PROPERTIES - UW S

- **Material:** Steel DD11 (material no. 1.0332) acc. to DIN EN10111
- **Zinc plating:** Electro zinc plated, min. 5 µm

TECHNICAL DATA

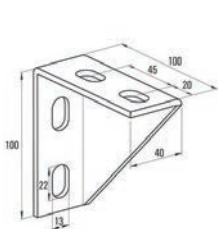

WK 100/100

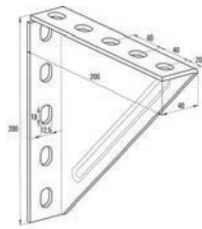

WK 200/200

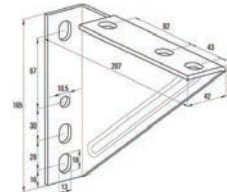

WK 207/165

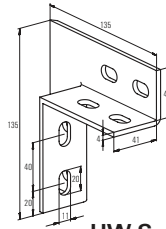

UW S

Item	Art.-NO.	Qty. per box (pcs.)
WK 100/100	063559	5
WK 200/200	079570	5
WK 207/165	079571	6
UW S	49479	4

LOADS

LOAD CASE 1

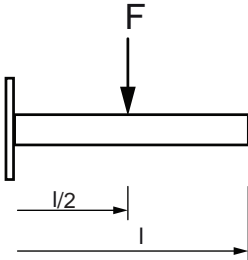

LOAD CASE 2

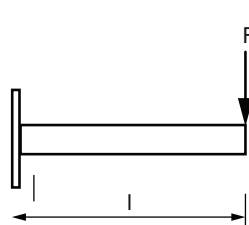

Item	Art.-NO.	Max. static load case 1		Max. static load case 2	
		F _{rec.} (kN)	F _{design} (kN)	F _{rec.} (kN)	F _{design} (kN)
WK 100/100	063559	-	-	4.0	5.6
WK 200/200	079570	4.0	5.6	1.8	2.5
WK 207/165	079571	-	-	1.8	2.5

LOADS - UW S

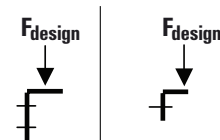
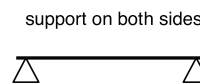
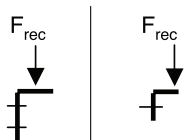
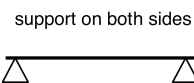

Connector	Channel	support on both sides		
		Double (kN)	Single (kN)	Torque (Nm)
FCN P M 10	41/21-2	5	2.5	40
	41/21-2.5	5	2.5	40
	41/41-2	5	2.5	40
	41/41-2.5	5	2.5	40
	41/62-2.5	5	2.5	40

Connector	Channel	support on both sides		
		Double (kN)	Single (kN)	Torque (Nm)
FCN P M 10	41/21-2	7	3.5	40
	41/21-2.5	7	3.5	40
	41/41-2	7	3.5	40
	41/41-2.5	7	3.5	40
	41/62-2.5	7	3.5	40

* load safety factor 1.4 is included

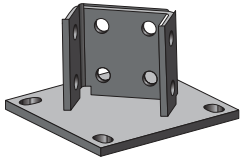

FBP 41D

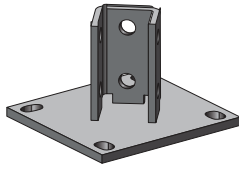

FBP 41H

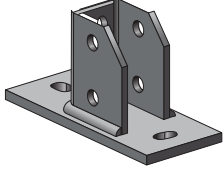

FBP 41N

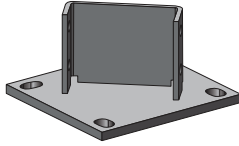

FBP 62D

PROPERTIES

- **Material:** Q235 high-quality carbon steel, profile thickness 8 mm
- **Surface treatment:** Galvanized, min 5 µm
Hot dip galvanized, min 45 µm
Epoxy coated, min 60 µm

TECHNICAL DATA

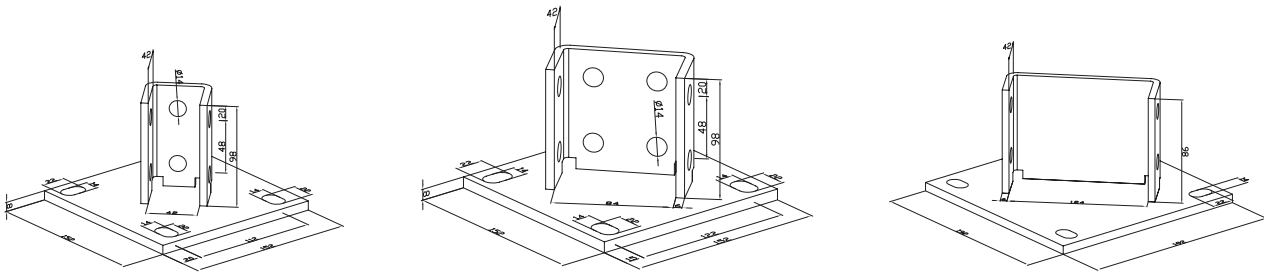

Item	Art.-NO.			Qty. per box (pcs.)
	HDG	Gal.	Epoxy	
FBP 41H	550450	550454	550458	4
FBP 41D	550451	550455	550459	4
FBP 41N	550467	550469	550602	6
FBP 62D	550453	550457	550461	4

Cover cap FEC



FEC 21 B



FEC 41 B



FEC 62 B

PROPERTIES

- **Material:** Polyethylene, black

TECHNICAL DATA

Item	Art.-NO.	Qty. per box (pcs.)	Fits to
FEC 21 B	077357	100	FUS 21, FUS 21 D
FEC 41 B	077355	100	FUS 41, FUS 41 D
FEC 62 B	505551	100	FUS 62, FUS 62 D
FEC 21	109551	100	FUS 21, FUS 21 D
FEC 41	109548	100	FUS 41, FUS 41 D

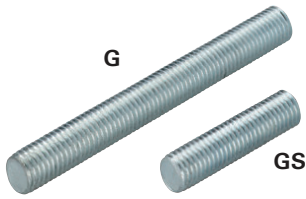

PROPERTIES THREADED ROD G

- **Material (G 6 – G 24):** DIN 976 Steel 4.8 acc. to DIN EN ISO 898-1
- **Material (G 1/2" – G 3/4"):** Steel S235 JR (material no. 1.0037) acc. to DIN EN 10025
- **Zinc plating:** Electro zinc plated, 5 - 8 µm

PROPERTIES THREADED STUD GS

- **Material:** DIN 976 Steel 4.6 acc. to DIN EN ISO 898-1
- **Zinc plating:** Electro zinc plated, 3 - 8 µm

PROPERTIES THREADED STUD GS A4

- **Material A4:** Stainless steel of the corrosion resistance class III, e.g. A4

PROPERTIES THREADED ROD G A2/A4

- **Material A2:** Stainless steel of the corrosion resistance class II, e.g. A2
- **Material A2:** Stainless steel of the corrosion resistance class III, e.g. A4

TECHNICAL DATA

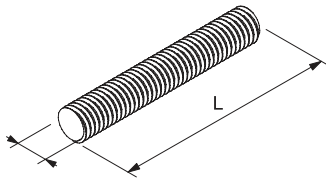

Item	Art.-NO.	Qty. per box (pcs.)	Length L (mm)	Thread M	Type	Art.-NO.	Qty. per box (pcs.)	Length L (mm)	Thread M
Threaded rod G					Threaded stud GS				
G 6	020956	50	1000	M 6	GS 8/25	079750	100	25	M 8
G 8	079740	25	1000	M 8	GS 8/40	079751	100	40	M 8
G 10	079744	25	1000	M 10	GS 8/50	079752	100	50	M 8
G 12	020957	20	1000	M 12	GS 8/60	079753	100	60	M 8
G 16	020958	10	1000	M 16	GS 8/70	079754	100	70	M 8
G 20	557295	5	1000	M 20	GS 8/80	079755	100	80	M 8
G 24	557270	5	1000	M 24	GS 8/100	079757	100	100	M 8
G 8/2	079741	25	2000	M 8	GS 8/150	079758	50	150	M 8
G 10/2	079745	25	2000	M 10	GS 8/200	079759	50	200	M 8
G 12/2	579746	25	2000	M 12	GS 10/25	079765	100	25	M 10
G 10/3	557092	5	3000	M 10	GS 10/40	079766	100	40	M 10
G 12/3	064056	5	3000	M 12	GS 10/60	079767	100	60	M 10
G 1/2"	064093	10	2000	1/2"	GS 10/80	079768	100	80	M 10
G 3/4"	077580	5	2000	3/4"	GS 10/100	079769	100	100	M 10
Stainless Steel A2					GS 10/120	079770	50	120	M 10
G 8 A2	77644	5	1000	M 8	GS 10/150	079771	50	150	M 10
G 10 A2	65173	5	1000	M 10	GS 10/200	079772	50	200	M 10
Stainless Steel A4					GS 12/40	091442	100	40	M 12
G 8 A4	77645	5	1000	M 8	GS 12/60	091443	100	60	M 12
G 10 A4	65174	5	1000	M 10	GS 12/80	091444	100	80	M 12
Threaded stud GS A4					GS 12/100	091461	100	100	M 12
GS 8/40 A4	505536	100	40	M 8	GS 12/120	091462	50	120	M 12
GS 8/60 A4	505537	100	60	M 8	GS 12/150	091463	50	150	M 12
GS 10/40 A4	505538	100	40	M 10	GS 12/200	091464	50	200	M 12
GS 10/60 A4	505539	100	60	M 10	-	-	-	-	-

LOADS

Technical Data - Threaded Rod GS

Item	Weight (kg/m')	Stressed area (mm ²)	Moment of inertia (mm ⁴)	Section modulus (mm ³)	Permissible tensile force (kN)
GS 8	0.39	37	201	50	5.3
GS 10	0.61	58	491	98	8.4
GS 12	0.88	84	1018	170	12.1

(1) - Yield strength = 240 Mpa (2) - Material safety factor = 1.2 & Load safety factor 1.4 are included

Technical Data - Threaded Rod G

Item	Weight (kg/m')	Stressed area (mm ²)	Moment of inertia (mm ⁴)	Section modulus (mm ³)	Permissible tensile force (kN)
G 6	0.22	20	64	21	3.9
G 8	0.39	37	201	50	7.0
G 10	0.61	58	491	98	11.1
G 12	0.88	84	1018	170	16.2
G 14	1.20	115	1885	269	22.2
G 16	1.57	157	3216	402	30.1
G 18	1.99	192	5152	572	37.0
G 20	2.45	245	7853	785	47.0
G 22	2.97	303	11497	1045	58.3
G 24	3.53	353	16283	1357	67.7

(1) - Yield strength = 320 Mpa (2) - Material safety factor = 1.2 & Load safety factor 1.4 are included



TRS

PROPERTIES

- **Material (G 6 – G 24):** Steel 4.8 acc. to ISO 898 - 1
- **Zinc plating:** Electro Galvanized, 5 - 8 µm

TECHNICAL DATA

Item	Art.-NO.	Qty. per box (pcs.)	Length	Thread
TRS 6x1 mtr GI	516559	50	1000	M 6
TRS 8x1 mtr GI	516560	25	1000	M 8
TRS 10x1mtr GI	516561	25	1000	M 10
TRS 12x1mtr GI	516562	20	1000	M 12
TRS 16x1mtr GI	516581	10	1000	M 16
TRS 20x1mtr GI	516564	5	1000	M 20
TRS 24x1mtr GI	516565	5	1000	M 24
TRS 6x2mtr GI	516568	25	2000	M 6
TRS 8x2mtr GI	516569	25	2000	M 8
TRS 10x2mtr GI	516570	25	2000	M 10
TRS 12x2mtr GI	516571	25	2000	M 12
TRS 16x2mtr GI	516563	10	2000	M 16
TRS 6x3mtr GI	516588	25	3000	M 6
TRS 8x3mtr GI	516573	25	3000	M 8
TRS 10x3mtr GI	516574	20	3000	M 10
TRS 12x3mtr GI	516575	10	3000	M 12
TRS 16x3mtr GI	516572	5	3000	M 16

Threaded rod TRSL



TRSL

PROPERTIES

- **Material:** ISO 898-1, DIN 975 & 976 (Steel: 4.8)
- **Finish:** Hot Dip Galvanized (as per ASTM A 153)
- **Material SS316:** DIN EN ISO 3506-1

TECHNICAL DATA

Item	Art.-NO.		Length	Thread
	HDG 4.8	SS 316		
TRSL 6x2 mtr	516576	516584	2000	M 6
TRSL 8x2 mtr	516578	516585	2000	M 8
TRSL 10x2 mtr	516579	516586	2000	M 10
TRSL 12x2 mtr	516580	516587	2000	M 12
TRSL 16x2 mtr	516582	516647	2000	M 16
TRSL 8x3 mtr	516583	516589	3000	M 8
TRSL 10x3 mtr	516557	516590	3000	M 10
TRSL 12x3 mtr	516558	516591	3000	M 12

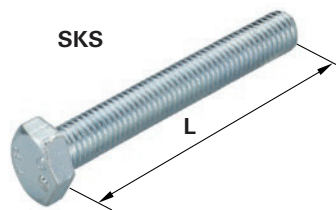

PROPERTIES

- **Zinc plating:** Electro zinc plated, 3 – 8 µm acc. DIN-EN-ISO 4017, steel 8.8
- **Material A4:** Stainless steel of the corrosion resistance class III, e.g. A4

TECHNICAL DATA

Item	Art.-NO.	Qty. per box (pcs.)	Length L (mm)	Thread D	Width across nut SW
SKS 6 x 20	079711	100	20	M 6	10
SKS 8 x 16	079415	100	16	M 8	13
SKS 8 x 30	079713	100	30	M 8	13
SKS 8 x 45	079714	100	45	M 8	13
SKS 8 x 55	079715	100	55	M 8	13
SKS 8 x 100	079827	100	100	M 8	13
SKS 10 x 20	079416	100	20	M 10	17
SKS 10 x 30	079417	100	30	M 10	17
SKS 10 x 55	079721	100	55	M 10	17
SKS 10 x 85	505552	100	85	M 10	17
SKS 12 x 20	077610	100	20	M 12	19
SKS 12 x 55	077611	100	55	M 12	19
SKS 12 x 85	505553	100	85	M 12	19
Stainless steel A4					
SKS M 10 x 30 A4	505547	100	-	M 10	17
SKS M 12 x 30 A4	505548	100	-	M 12	19

Hexagonal Bolt SKSL



PROPERTIES

- **Material:** DIN 933 (Steel: 8.8)
- **Finish:** Electro Galvanized (as per ASTM B633), Hot Dip Galvanized (as per ASTM A153)
- **Material SS316:** DIN EN ISO 3506-1

TECHNICAL DATA

Item	Art.-NO. GI 8.8	Art.-NO. HDG 8.8	Art.-NO. SS 316	Length L (mm)	Thread D	Item	Art.-NO. GI 8.8	Art.-NO. HDG 8.8	Art.-NO. SS 316	Length L (mm)	Thread D
SKSL M 6x16	516755	-	-	16	M 6	SKSL M 12x25	516786	-	-	25	M 12
SKSL M 6x20	-	516797	-	20	M 6	SKSL M 12x30	-	516595	-	30	M 12
SKSL M 6x25	516756	516798	516606	25	M 6	SKSL M 12x35	516787	-	-	35	M 12
SKSL M 6x40	516757	-	-	40	M 6	SKSL M 12x40	516788	-	516615	40	M 12
SKSL M 6x50	-	-	516607	50	M 6	SKSL M 12x50	516789	-	516616	50	M 12
SKSL M 8x16	516758	-	-	16	M 8	SKSL M 12x55	-	516596	516617	55	M 12
SKSL M 8x20	516759	516799	-	20	M 8	SKSL M 12x60	516790	-	516618	60	M 12
SKSL M 8x25	516761	-	-	25	M 8	SKSL M 12x75	-	-	516619	75	M 12
SKSL M 8x30	516763	-	-	35	M 8	SKSL M 12X100	-	-	516620	100	M 12
SKSL M 8x35	516762	516800	-	30	M 8	SKSL M 12X110	-	-	516621	110	M 12
SKSL M 8x45	516764	-	-	45	M 8	SKSL M 12x120	-	-	516622	120	M 12
SKSL M 8x55	516778	-	-	55	M 8	SKSL M 16x30	516791	-	-	30	M 16
SKSL M 8x80	-	516552	-	80	M 8	SKSL M 16x35	516792	-	-	35	M 16
SKSL M 10x16	516779	-	-	16	M 10	SKSL M 16x40	516793	-	-	40	M 16
SKSL M 10x20	516780	516553	-	20	M 10	SKSL M 16x50	516794	-	-	50	M 16
SKSL M 10x25	516781	516554	516608	25	M 10	SKSL M 16x55	-	516597	-	55	M 16
SKSL M 10x30	516782	516555	-	30	M 10	SKSL M 16x70	516795	-	-	70	M 16
SKSL M 10x35	516783	-	-	35	M 10	SKSL M 16x80	-	516598	516623	80	M 16
SKSL M 10x40	-	516556	-	40	M 10	SKSL M 16x100	-	516599	516624	100	M 16
SKSL M 10x50	-	516592	516609	50	M 10	SKSL M 20x40	516796	-	-	40	M 20
SKSL M 10x55	516784	-	-	55	M 10	SKSL M 20X90	-	516600	-	90	M 20
SKSL M 10x60	-	516593	516610	60	M 10	SKSL M 20X125	-	516601	516625	125	M 20
SKSL M 10x70	-	-	516611	70	M 10	SKSL M 20X130	-	516602	-	130	M 20
SKSL M 10x90	-	-	516612	90	M 10	SKSL M 22X80	-	-	516626	80	M 22
SKSL M 10x100	-	516594	-	100	M 10	SKSL M 22X100	-	516603	-	100	M 22
SKSL M 10x110	-	-	516613	110	M 10	SKSL M 24X150	-	516604	516627	150	M 24
SKSL M 10x120	-	-	516614	120	M 10	SKSL M 24X180	-	516605	-	180	M 24
SKSL M 12x20	516785	-	-	20	M 12	-	-	-	-	-	-

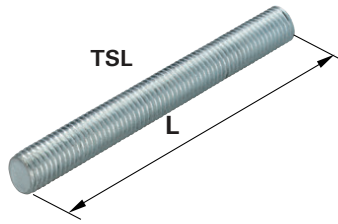

PROPERTIES

- **Material:** ISO 898-1, DIN 975 & 976 (Steel: 8.8)
- **Finish:** Electro Galvanized (as per ASTM B633), Hot Dip Galvanized (as per ASTM A153)
- **Material SS316:** DIN EN ISO 3506-1

TECHNICAL DATA

Item	Art.-NO. GI 8.8	Art.-NO. HDG 8.8	Art.-NO. SS 316	Length L (mm)	Thread M
M 8 x 80	-	-	516659	80	M 8
M 8 x 110	-	-	516660	110	M 8
M 8 x 150	-	516649	516661	150	M 8
M 10 x 100	-	-	516634	100	M 10
M 10 x 120	-	-	516635	120	M 10
M 10 x 140	-	516650	-	140	M 10
M 10 x 150	-	-	516636	150	M 10
M 10 x 190	-	516651	516637	190	M 10
M 12 x 120	-	-	516638	120	M 12
M 12 x 150	-	516652	516639	150	M 12
M 12 x 200	-	516653	516640	200	M 12
M 16 x 60	516628	-	-	60	M 16
M 16 x 80	516629	-	-	80	M 16
M 16 x 100	516630	-	-	100	M 16
M 16 x 150	516631	-	516641	150	M 16
M 16 x 200	-	516654	516642	200	M 16
M 16 x 300	-	516655	516643	300	M 16
M 16 x 380	-	-	516644	380	M 16
M 20 x 180	-	-	516645	180	M 20
M 20 x 260	-	516656	505536	260	M 20
M 20 x 350	-	-	505537	350	M 20
M 20 x 380	516633	516657	-	380	M 20
M 20 x 450	-	-	505538	450	M 20
M 24 x 300	516648	516658	505539	300	M 24
M 24 x 450	-	-	516646	450	M 24

Reduction socket RDM and GRD



RDM



GRD

PROPERTIES

- **Material:** 11SMnPb30 (material no. 1.0277) acc. to DIN EN 10277
- **Zinc plating:** Electro zinc plated, 3-8 µm

TECHNICAL DATA

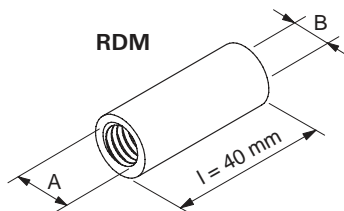

RDM

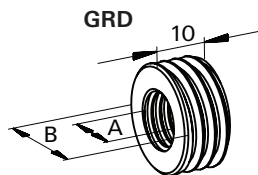

GRD

Item	Art.-NO.	Qty. per box (pcs.)	Thread A	Length B
RDM M 10 / M 8	079413	50	M 10	M 8
RDM M 12 / M 10	079414	100	M 12	M 10
GRD 1/2" / M10	077609	100	M 10	1/2"
GRD 1/2" / M12	077608	100	M 12	1/2"
GRD 3/4" / M10	077607	100	M 10	3/4"
GRD 3/4" / M12	077606	100	M 12	3/4"



MU

PROPERTIES

- **Material:** acc. DIN EN 20898-2; min. strength category 04
- **Zinc plating:** Electro zinc plated, min. 5 µm
- **Material A4:** Stainless steel of the corrosion resistance class III, e.g. A4

TECHNICAL DATA

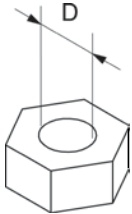

Item	Art.-NO.	Qty. per box (pcs.)	Thread D	Width across nut SW
MU M 6	079733	100	M 6	10
MU M 8	079734	100	M 8	13
MU M 10	079735	100	M 10	17
MU M 12	024650	100	M 12	19
MU M 16	55727	50	M 16	24
Stainless steel A4				
MU M 8 A4	77642	100	M 8	13
MU M 10 A4	77641	100	M 10	17

Hexagonal nut HN



HN

PROPERTIES

- **Material:** DIN 439
- **Finish:** Electro Galvanized (as per ASTM B633), Hot Dip Galvanized (as per ASTM A153)
- **Material A4:** Stainless steel of the corrosion resistance class III, e.g. A4

TECHNICAL DATA

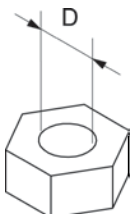

Item	Art.-NO. GI	Art.-NO. HDG	Art.-NO. SS316	Thread D (mm)
HN M6	516801	516806	516811	M 6
HN M8	516802	516807	516812	M 8
HN M10	516803	516808	516813	M 10
HN M12	516804	516809	516814	M 12
HN M16	516805	516810	516815	M 16
HN M20	516739	516741	516743	M 20
HN M24	516740	516742	516744	M 24



U

PROPERTIES

- **Material:** Steel DD11 (material no.1.0139) acc. to DIN EN 10111
- **Zinc plating:** Electro zinc plated, min. 3 µm
- **Material A4:** Stainless steel of the corrosion resistance class III, e.g. A4

TECHNICAL DATA

Item	Art.-NO.	Qty. per box (pcs.)	Thickness S (mm)	External Ø A (mm)	Hole Ø (mm)
U 6 x 24	020939	200	2	24	6.4
U 8 x 17	091477	100	1.6	17	8.4
U 8 x 28	079725	100	2	28	8.4
U 8 x 40	079729	100	3	40	8.4
U 10 x 21	091478	100	2	21	10.5
U 10 x 28	079726	100	2	28	10.5
U 10 x 40	079730	100	3	40	13
U 12 x 24	557301	100	2.5	24	13
U 12 x 40	024649	100	3	40	16.5
U 16 x 30	557303	50	3	30	16.5
U 8 x 28 A4	505542	100	2	28	8.4
U 8 x 40 A4	505543	100	3	40	8.4
U 10 x 28 A4	505544	100	2	30	10.5
U 10 x 40 A4	505545	100	3	40	10.5
U 12 x 24 A4	505546	100	2	24	12.5

Washer MW



MW

PROPERTIES

- **Material:** DIN 125
- **Finish:** Electro Galvanized (as per ASTM B633), Hot Dip Galvanized (as per ASTM A153)
- **Material A4:** Stainless steel of the corrosion resistance class III, e.g. A4

TECHNICAL DATA

Item	Art.-NO.			Thread D (mm)
	GI	HDG	SS316	
MW M6X12	516816	516832	516824	M 6
MW M8X16	516817	516833	516825	M 8
MW M8X30	516818	516834	516826	M 8
MW M8X40	516819	516835	516827	M 8
MW M10x20	516820	516836	516828	M 10
MW M10x30	516821	516837	516829	M 10
MW M10x40	516822	516838	516830	M 10
MW M12x24	516823	516839	516831	M 12
MW M16x30	516770	516745	516748	M 16
MW M16x40	516771	-	-	M 16
MW M20x37	516772	516746	516749	M 20
MW M24x44	516773	516747	516760	M 24



VM

PROPERTIES

- **Material:** SAE 1008 (material no. 1.0213) acc. to DIN EN 10263-2
- **Zinc plating:** Electro zinc plated, 3-8 µm
- **Material A4:** Stainless steel of the corrosion resistance class III, e.g. A4

TECHNICAL DATA

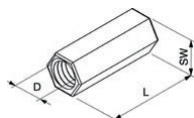

Item	Art.-NO.	Qty. per box (pcs.)	Length L (mm)	Thread D	Width across nut SW
VM M 6	014319	100			
VM M 8	079690	100	30	M 8	11
VM M 10	079691	100			
VM M 12	020971	100	40	M 12	17
VM M 12S*	077623	100			
VM M 16	508833	50	40	M 16	24
VM M 8 A4	505540	100			
VM M 10 A4	505541	100	30	M 10	13

Reduction piece RD



RD

PROPERTIES

- **Material:** 9SMnPb28k (material no. 1.0718) acc. to DIN EN 10087
- **Zinc plating:** Electro zinc plated, 3 – 8 µm

TECHNICAL DATA

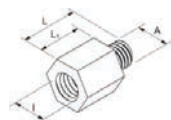

Item	Art.-NO.	Qty. per box (pcs.)	Internal thread I	External thread A	Length L1 (mm)	Length L (mm)	Width across nut SW
RD M 6 / M 8	079694	100	M 6	M 8	12	20	9
RD M 8 / M 6	020936	100	M 8	M 6	12	19	11
RD M 10 / M 8	079692	50	M 10	M 8	15	23	13
RD M 12 / M 10	079693	100	M 12	M 10	15	25	17
RD M 12 / M 16	504397	50	M 12	M 16	18	32	19
RD M 16 / M 12	504399	50	M 16	M 12	22	32	24
RD 1/2" / M 10	079695	100	1/2"	M 10	19	29	24



PROPERTIES

- **Material Cap:** Steel DD 11 (material no. 1.0332) acc. to DIN EN 10111
- **Material Sliding nut:** Steel S420MC, EN 10149-2
- **Material Hexagon nut:** 8.8 M 1028, DIN 933
- **Material Plastic parts:** Polypropylene
- **Zinc plating:** Electro zinc plated acc. to DIN 50979, min. 8 µm

TECHNICAL DATA

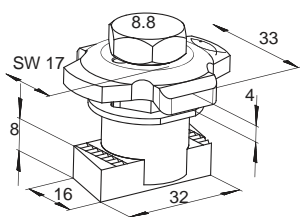

Item	Art.-NO.	Thread A	Sales unit (pcs.)
PFCN 41	533739	M 10	50

LOADS

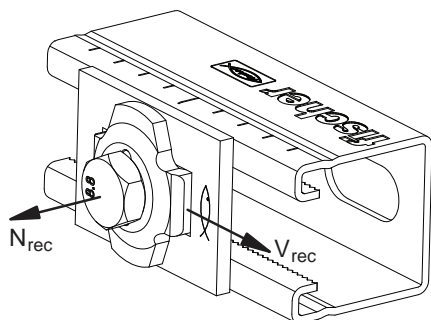

Item	Art.-NO.	Max. recommended tension load for FUS 2.0mm N _{rec} (kN)	Max. recommended tension load for FUS 2.5mm N _{rec} (kN)	Max. recommended Shear load V _{rec} (kN)	Tightening torque for screw grade ≥ 8.8 T _{inst} (kN)
PFCN 41	533739	5.0	7.0	3.5	40

(1) Load values are based on the PFCN 41 push-through connector.

Push-through saddle flange PSF



PROPERTIES

- **Material:** Steel DD 11 (material no. 1.0332) acc. to DIN EN 10111
- **Zinc plating:** Electro zinc plated acc. to DIN 50979, min. 8 µm

TECHNICAL DATA

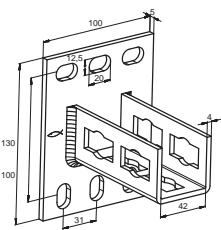

PSF 41

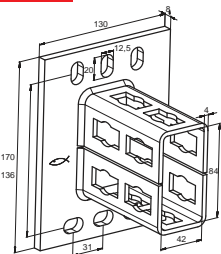

PSF 82

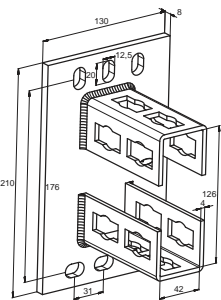

PSF 124

Item	Art.-NO.	For profile	Sales unit (pcs.)
PSF 41	533740	210, 41, 62	10
PSF 82	533741	41 D	5
PSF 124	533742	62 D	5

Push-through bracket

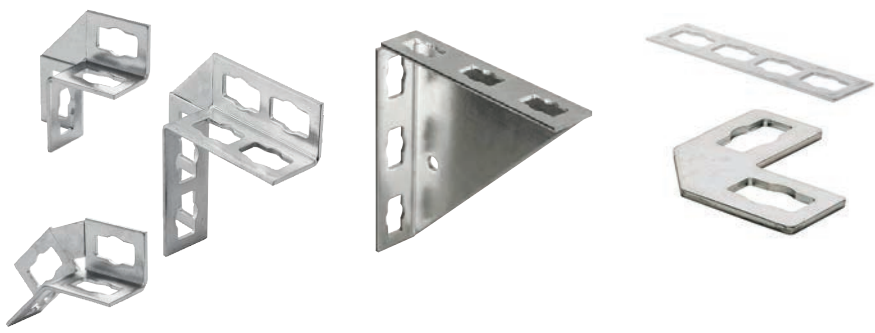

PROPERTIES

- **Material:** Steel DD 11 (material no. 1.0332) acc. to DIN EN 10111
- **Zinc plating:** Electro zinc plated acc. to DIN 50979, min. 8 µm

TECHNICAL DATA

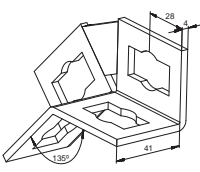

PUWS 2 x 2/135°

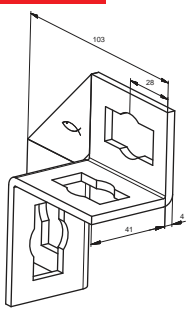

PUWS 2 x 2

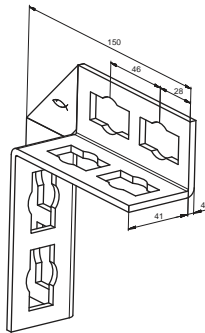

PUWS 4 x 4

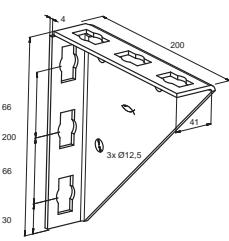

PWK 200/200

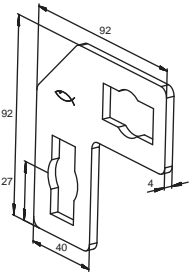

PFFF

Item	Art.-NO.	Sales unit (pcs.)
PUWS 2 x 2/135°	533731	10
PUWS 2 x 2	533733	10
PUWS 4 x 4	533734	8
PWK 200/200	533744	15
PFFF 2L	533745	20
PFFF 4L	535268	25

Push-through bracket PFAF / PFUF

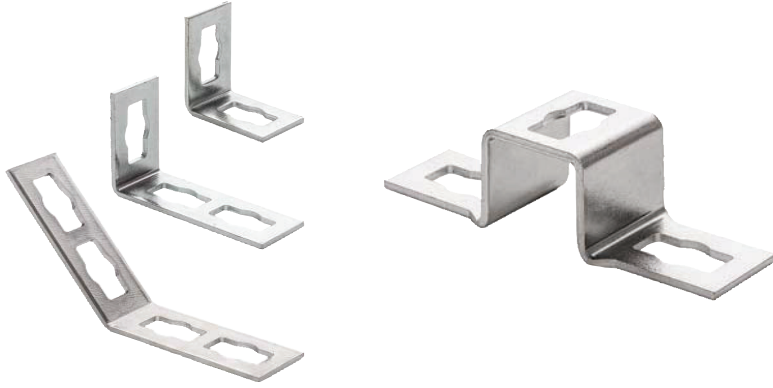

PROPERTIES

- **Material:** Steel DD 11 (material no. 1.0332) acc. to DIN EN 10111
- **Zinc plating:** Electro zinc-plated acc. to DIN 50979, min. 8 µm

TECHNICAL DATA

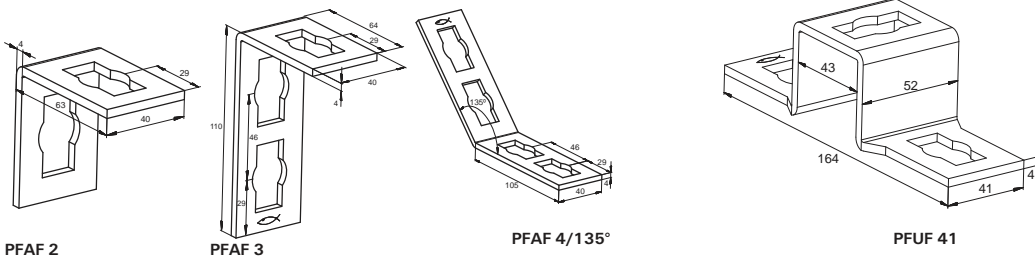

Item	Art.-NO.	Sales unit (pcs.)
PFAF 2	533735	25
PFAF 3	533736	25
PFAF 4/135°	533737	20
PFUF 41	533738	25

Push-through brackets PFUF D

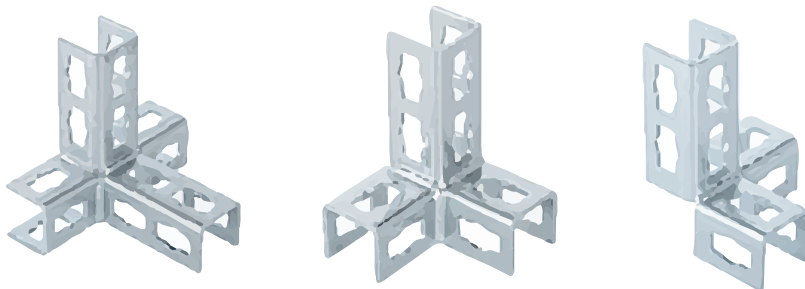

PROPERTIES

- **Material:** Steel DD 11 (material no. 1.0332) acc. to DIN EN 10111
- **Zinc plating:** Electro zinc-plated acc. to DIN 50979, min. 8 µm

TECHNICAL DATA

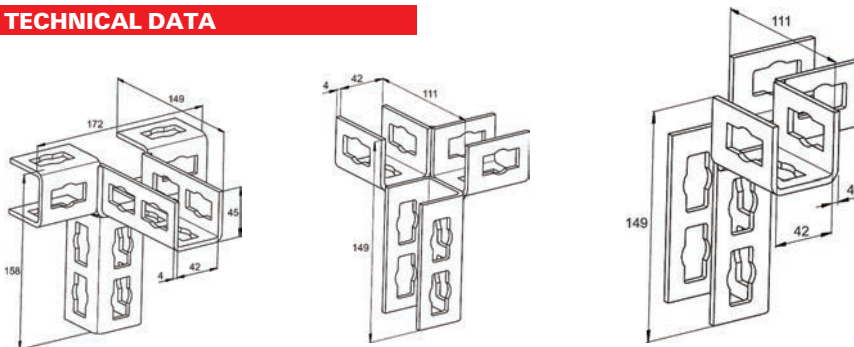

Item	Art.-NO.	Sales unit (pcs.)
PFUF 4D	535275	10
PFUF 3D	535274	10
RPFUF 3DL	535273	10



PROPERTIES

- **Material:** Steel DD 11 (material no. 1.0332) acc. to DIN EN 10111
- **Zinc plating:** Electro zinc-plated acc. to DIN 50979, min. 8 µm

TECHNICAL DATA

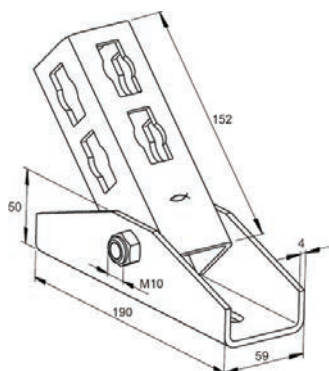

Item	Art.-NO.	Sales unit (pcs.)
PVB	534960	5

Push-through bracing elements PSAE

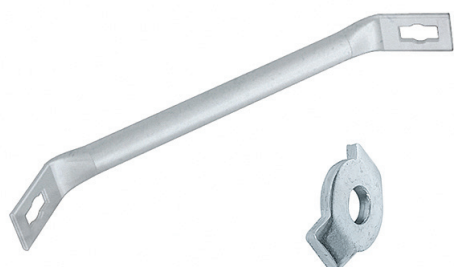

PROPERTIES

- **Material:** Steel DD 11 (material no. 1.0332) acc. to DIN EN 10111
- **Zinc plating:** Electro zinc-plated acc. to DIN 50979, min. 8 µm

TECHNICAL DATA

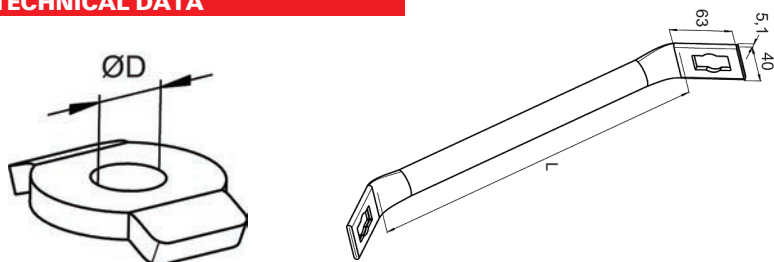

Item	Art.-NO.	Length l (mm)	Sales Unit (pcs.)
PSAE 300 Brace element	535269	300	10
PSAE 500 Brace element	535270	500	10
PU 10,5 Washer	535271		50
PU 12,5 Washer	535272		50



PROPERTIES

- **Material:** Steel S-250-GD (material no.: 1.0242) acc. to DIN EN 10346
- **Zinc plating:** Sendzimir-galvanised, app. 20 µm

TECHNICAL DATA

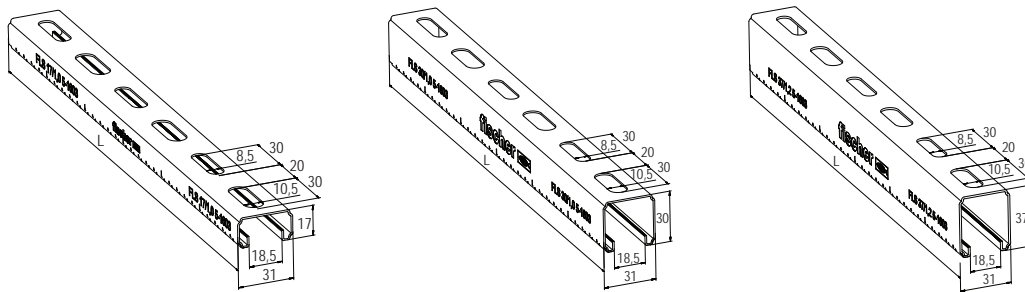

Item	Art.-NO.	Fire test report	Thickness S (mm)	Length l (mm)	Sales Unit (pcs.)
FLS 17/1.0 - 2 m	538753		1.0	2000	10
FLS 17/1.0 - 3 m	538754		1.0	3000	8
FLS 30/1.0 - 2 m	538755		1.0	2000	10
FLS 30/1.0 - 3 m	538756		1.0	3000	8
FLS 37/1.2 - 2 m	538757	X	1.2	2000	10
FLS 37/1.2 - 3 m	538758	X	1.2	3000	8
FLS 37/1.2 - 6 m	538759	X	1.2	6000	1

Cantilever arm ALK



PROPERTIES

- **Material Base plate:** Steel E295 (material no.: 1.0050) acc. to DIN EN 10025-2
- **Material Channel:** Steel S2 15 G (material no.: 10116 G) acc. to DIN 1623
- **Zinc plating:** Electro zinc-plated, min. 13 µm

TECHNICAL DATA

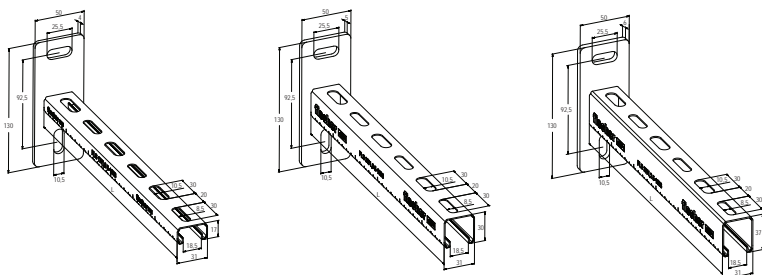

APPROVALS



Item	Art.-NO.	Profile	Length l (mm)	Sales Unit (pcs.)
ALK 17-200	538738	17/1.0	200	10
ALK 17-300	538739	17/1.0	300	10
ALK 30-200	538740	30/1.0	200	10
ALK 30-300	538741	30/1.0	300	10
ALK 30-450	538742	30/1.0	450	10
ALK 37-300	538743	37/1.2	300	10
ALK 37-450	538744	37/1.2	450	10
ALK 37-600	538745	37/1.2	600	5



Angle brace

PROPERTIES

- **Material:** Steel S235 JR (material no.: 1.0037) acc. to DIN EN 10025
- **Zinc plating:** Electro zinc-plated, min. 20 µm acc. DIN EN ISO 4042

TECHNICAL DATA

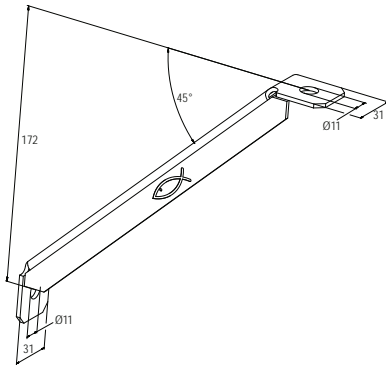

Item	Art.-NO.	Eye Ø D (mm)	Sales unit (pcs.)
WS 31-45°	538749	11	10

Channel connector SV 31



Channel Connection

PROPERTIES

- **Material:** Steel S235 JR+CR (material no.: 1.0037) acc. to DIN EN 1652
- **Zinc plating:** Electro zinc-plated, min. 5 µm acc. DIN EN ISO 4042

TECHNICAL DATA

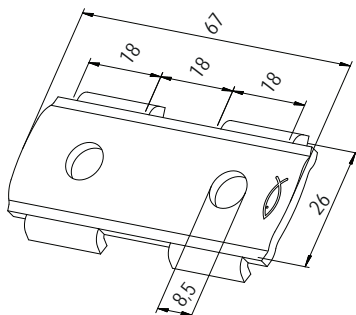

Item	Art.-NO.	Hole diameter D (mm)	Sales unit (pcs.)
SV 31	538641	8.5	25



PROPERTIES

- **Material channel nut:** Steel S420MC (material no.: 1.0980) acc. DIN EN 10149-2
- **Material plastic cage:** Polypropylene PP, item number 11400, Color black
- **Zinc plating:** Electro zinc-plated, min. 13 µm acc. DIN EN ISO 4042

APPROVALS



TECHNICAL DATA

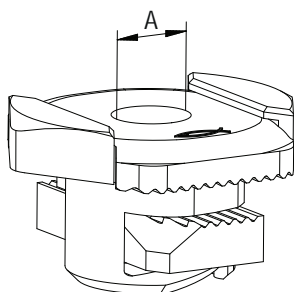

Item	Art.-NO.	Thread A	Sales unit (pcs.)
FSM Clix P 6	538643	M 6	50
FSM Clix P 8	538647	M 8	50
FSM Clix P 10	538649	M 10	50

Channel washer HK 31

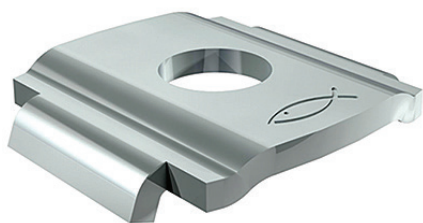

PROPERTIES

- **Material:** Steel S235 JR+CR (material no.: 1.0037) acc. to DIN EN 1652
- **Zinc plating:** Electro zinc-plated, min. 5 µm acc. DIN EN ISO 4042

APPROVALS



TECHNICAL DATA

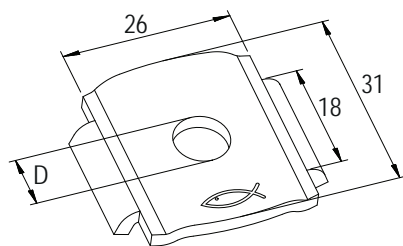

Item	Art.-NO.	Hole diameter D (mm)	Sales unit (pcs.)
HK 31 8.5	538663	8.5	50
HK 31 10.5	538664	10.5	50

Elongation (Thermal Expansion)

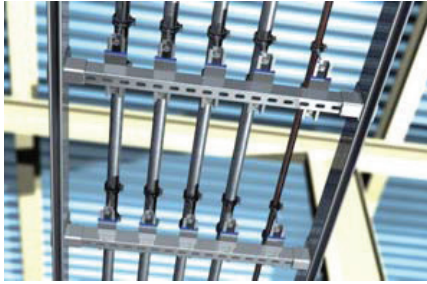

Materials expand with heat. For long components, the change in length is mainly considered. So it is not always a matter of expansion. Shrinkage upon cooling is also to be included in the calculation. This is important when installing pipes. Within piping, the change in length is to be specifically steered. Not doing this during installation results not only in pipe defects, but also in serious damage to components. It is therefore essential to determine how great the change in the length of a pipe can be. For this purpose, the pipe length and the expansion coefficient of the pipe material, as well as the expected temperature difference, must be known. This is to be determined such that not only the normal operating temperatures, but also the maximum temperatures that can arise in a case of malfunction, are taken into account. The range is therefore from around 10°C assembly temperature up to 95°C service temperature for water filled systems.

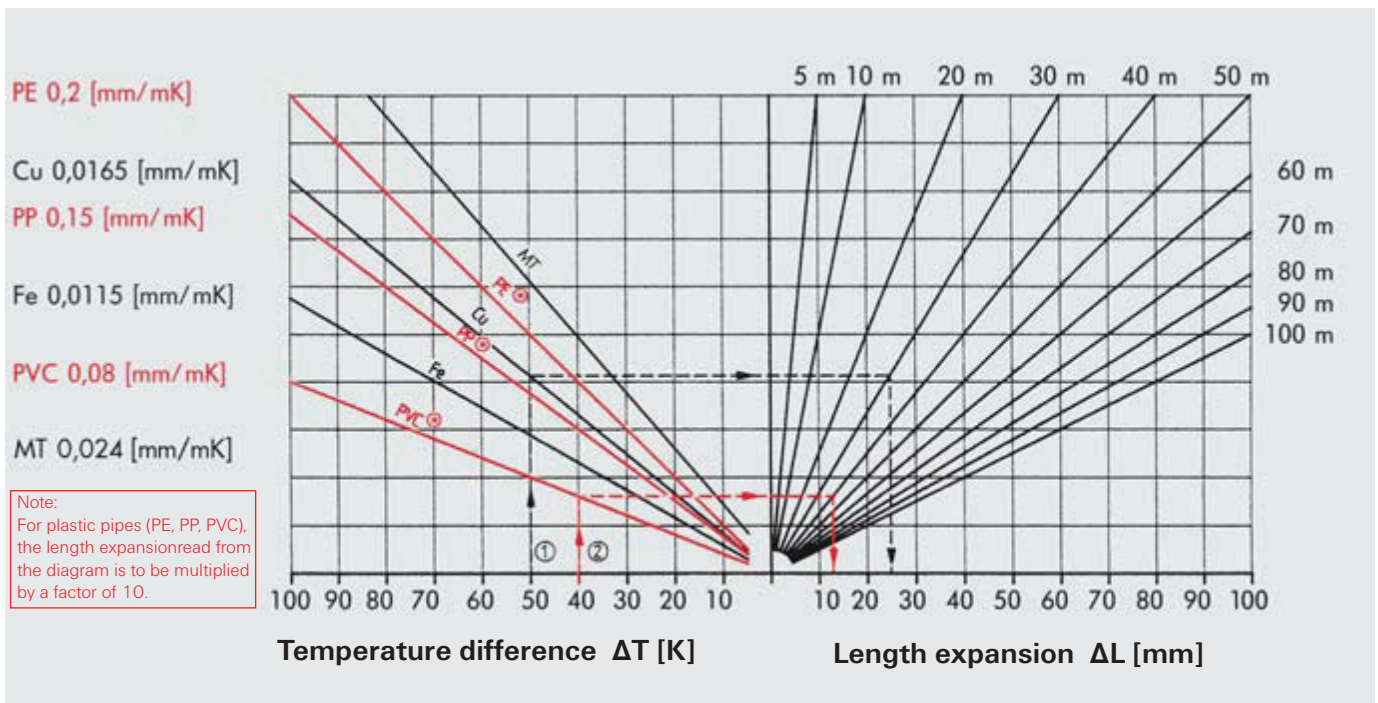

Length expansion calculation formula
 $\Delta L = L \cdot \Delta T \cdot \alpha$
 [mm] [m] [K] [mm/m K]

ΔL = Change in length
 L = Length of the pipe span/section
 ΔT = Temperature difference
 α = Length expansion coefficient

Example:

■ Copper pipe, Cu - Length of pipe span 30 m
 Temperature difference $\Delta T = 50$ K
 Length expansion $\Delta L = 24,75$ mm

■ PVC pipe - Length of pipe span L = 40 m
 Temperature difference $\Delta T = 40$ K
 Length expansion $\Delta L = 128$ mm (table value x 10)

Corrosion protection



In most cases, pipes and supply lines are installed in dry rooms. Therefore, in addition to corrosion resistant materials, such as plastics or stainless steel and copper, the steel products used for installation systems are galvanised. A zinc coating thickness of 5-8 µm by means of electrolytic process (galvanising) is standard.

For mounting rails, Sendzimir galvanised material is mainly used. Sendzimir galvanising is a method in which the material is drawn through a molten zinc bath, thereby achieving a zinc layer thickness of 12-20 µm. This method is used when there is no more welding for the subsequent processing. This is the case for mounting rails because they are cold-formed after galvanising. By cutting and stamping the holes, the surface in this area is not completely covered by a protective layer. Punched mounting rails are therefore only recommended for the dry interior rooms.

For cantilever brackets, non-galvanised channel pieces are used which are welded to the base plate. Following completion, the entire component is galvanised, creating a zinc coating thickness of 5-8 µm.

Threaded parts are either galvanised or made of stainless steel. Hot dip galvanising is less suitable for this because the large zinc layer thickness of 40-150 µm severely impairs the thread engagement.

If installation systems are installed outdoors or in wet interior rooms, they must be made of either hot dip galvanised steel or stainless steel.

Hot dip galvanising is very well suited to the protection of steel. The corrosion process is thus 10 times slower than with galvanising. The zinc loss depends on the surrounding atmosphere and humidity. An annual zinc reduction of 1 - 10 µm can, however, be assumed. The layer thickness is therefore crucial to the durability of the material.

Crucial here are the environmental influences under which the systems are installed. An overview of the expected impact on the protective action can be seen in the following diagram and tables.

hot-dip galvanized steel:

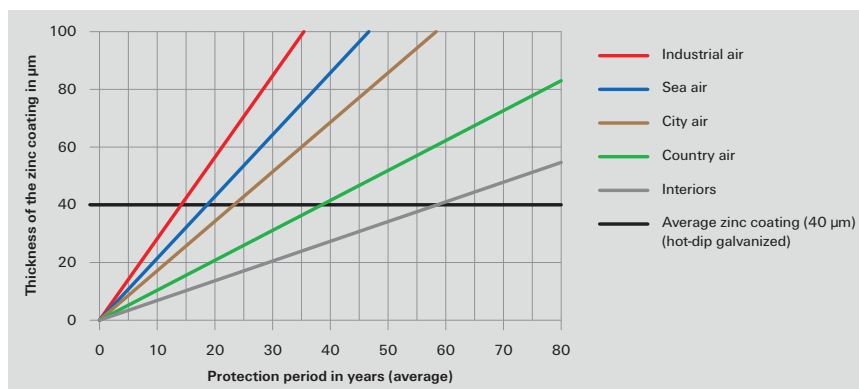

Stainless steel

Steel Grade				Designation of the Steel Group with	Corrosion	
Material No.	Short Name	AISI	UNS		Resistance Class	Exposure and Typical Applications
1.4305	X8CrNi18-9	303	S 30300	A1	I / light	Indoor climate except damp location.
1.4301	X5CrNi18-10	304	S 30400	A2	II / moderate	Accessible constructions without nameable content of chlorides or sulfur dioxide, except industrial atmosphere.
1.4307	X2CrNi 18-9	304L	S 30403	A2L		
1.4362	X2CrNiN23-4	324	S32304	A4	III / medium	Constructions with moderate chloride and sulfur dioxide exposure and inaccessible constructions.
1.4401	X5Cr-NiMo17-12-2	316	S 31600			
1.4404	X2Cr-NiMo17-12-2	316 L	S 31603			
1.4571	X6CrNi-MoTi17-12-2	316 Ti	S 31635	A5	IV / strong	High corrosion exposure due to chlorine, chloride and/or sulfur dioxide, high humidity as well as accumulation of hazardous substances.
1.4529	X1NiCrMo-CuN25-20-7	-	N 08926	1.4529		

Fire protection



Fire protection in pipe installations according to the latest standards.

- Fire-proof installations for individual pipes and pipe routes from R30 - R120 or F30 to F120.
- Proof of compliance with the criteria of MLAR (German standard pipe system directive) for installation in escape and rescue routes

Fire protection - protection goals

Firstly, fire protection serves to protect people and is regulated by the building laws in the respective countries (or regional states). Secondly, fire protection serves to protect property and this is regulated by the insurance associations, such as VdS and FM. These requirements partially go beyond the building legislation. This is particularly evident in the installation of fire protection systems, such as sprinklers, etc., as approved or recognised components must be used here. (See the following section for further details on this)

Fire inspection reports for the mounting of pipe clamps and mounting rails

Fire safety inspection reports meet the requirements for fire protection according to the building regulations of the countries and especially for Germany, according to the nationwide homonymic of German pipe systems directive (LAR), based on the standard pipe systems directive of 2005 (MLAR 2005).

Personal protection is defined in the MLAR Directive through clear rules for escape routes, such as corridors, stairwells and hallways between stairwells and the exit.

The key message is to ensure the safety of the escape route by ensuring the functioning of the fire-proof sub-ceiling. To this end, compliance with the minimum distance of $\min a \leq 50\text{mm}$ according to MLAR is required between installations and underlying suspended fire-proof F30 sub-ceilings (fire resistance of 30 minutes). Based on the fire inspections, load information for a fire resistance of 30 minutes in relation to the maximum permissible deformation of mounting rails or pipe clamps, for example. The necessity for these considerations arises from the properties of the steel, which at 30 minutes is subjected to a temperature of $>800^\circ\text{C}$ according to the standard temperature curve (ISO curve).

Reduction factors k_θ

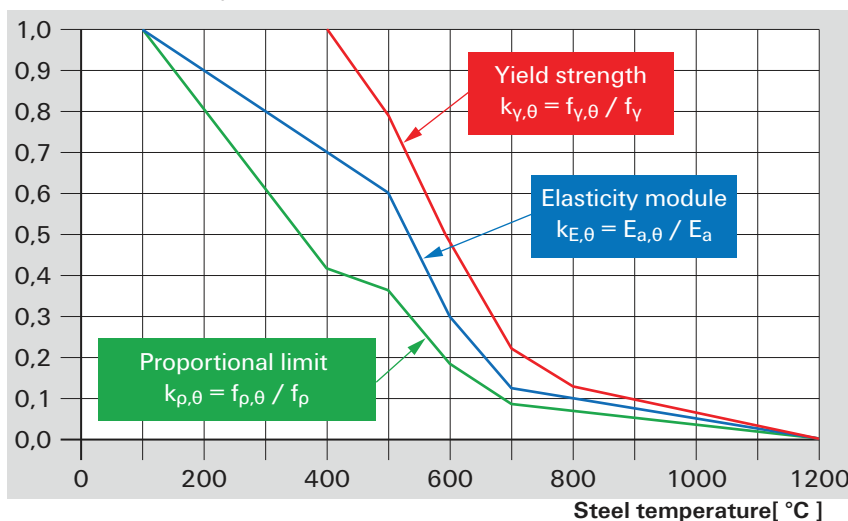

Dependency of the yield strength, proportional limit and elasticity module on the temperature (basis: EN1993-1-2:2012-12 Eurocode 3).

Additionally, the same information is documented in the inspection reports for a fire resistance rating of R30, R60, R90 and R120 according to EN1363-1 and DIN4102-2. (see following load tables)

Product overview with proof in inspection reports and supplementary sheets.

Product	Document no.	MLAR	R30 - R120	F30 - F120
FRS	MPA Braunschweig - 3649/384/12	•	•	
FUS / FCA	MPA Braunschweig - 3147/252/12	•	•	
FRS-F	MPA-NRW - 210005109-1	•		•
SB	MPA-NRW - 210005109-7			•
SBS	MPA-NRW - 210005109-4	•		•
PDH-K	MPA-NRW - 210005109-6	•		•

Dimensions and weights of pipes, ventilation ducts and ventilation pipes (Schedule 40 G.I)

S.no.	Nom. Pipe Size	Out Diameter	Inner Diameter	Out Diameter	Inner Diameter	Weight of pipe	Weight of water in pipe	Total pipe weight filled with
		in	in	mm	mm	kg/M ¹	kg/M ¹	kg/M ¹
1.	1/8"	0.405	0.269	10.3	6.8	0.4	0.04	0.4
2.	1/4"	0.540	0.364	13.7	9.2	0.6	0.1	0.7
3.	3/8"	0.675	0.493	17.1	12.5	0.8	0.1	1.0
4.	1/2"	0.840	0.622	21.3	15.8	1.3	0.2	1.5
5.	3/4"	1.050	0.824	26.7	20.9	1.7	0.3	2.0
6.	1"	1.315	1.049	33.4	26.6	2.5	0.6	3.1
7.	1 1/4"	1.660	1.380	42.2	35.1	3.4	1.0	4.3
8.	1 1/2"	1.900	1.610	48.3	40.9	4.0	1.3	5.4
9.	2"	2.375	2.067	60.3	52.5	5.4	2.2	7.6
10.	2 1/2"	2.875	2.469	73.0	62.7	8.6	3.1	11.7
11.	3"	3.500	3.068	88.9	77.9	11.3	4.8	16.0
12.	3 1/2"	4.000	3.548	101.6	90.1	13.6	6.4	19.9
13.	4"	4.500	4.026	114.3	102.3	16.1	8.2	24.3
14.	5"	5.563	5.047	141.3	128.2	21.8	12.9	34.6
15.	6"	6.625	6.065	168.3	154.1	28.2	18.6	46.8
16.	8"	8.625	7.981	219.1	202.7	42.5	32.1	74.6
17.	10"	10.750	10.020	273.1	254.5	60.2	50.7	111.0
18.	12"	12.750	11.938	323.9	303.2	79.7	72.2	151.8
19.	14"	14.000	13.000	355.6	330.2	94.3	87.0	181.3
20.	16"	16.000	15.000	406.4	381.0	123.2	113.8	237.0
21.	18"	18.000	16.874	457.2	428.6	155.9	144.6	300.5
22.	20"	20.000	18.814	508.0	477.9	182.9	179.2	362.0
23.	24"	24.000	22.626	609.6	574.7	254.7	259.2	513.9

Weights of galvanized ventilation ducts in kg/m without insulation

Sheet metal 0.75			Sheet metal 0.88							Sheet metal 1.0							Sheet metal 1.13							Sheet metal 1.25					◀ B	▶ H
200	224	250	280	315	355	400	450	500	560	630	710	800	900	1000	1120	1250	1400	1600	1800	2000	2240	2500	2800	3150						
6.6	7.0	7.4	9.3	10.0	10.7	11.6	12.6	13.6	16.7	18.3	20.0	22.0	24.2	26.4	32.8	36.0	39.8	44.7	49.7	54.7	70.2	77.6	86.3	96.3	200					
	7.4	7.8	9.8	10.4	11.2	12.1	13.0	14.0	17.2	18.8	20.5	22.5	24.7	26.9	33.4	36.6	40.4	45.3	50.3	55.3	70.8	78.3	86.9	97.0	224					
		8.3	10.3	10.9	11.7	12.6	13.6	14.5	17.8	19.4	21.1	23.1	25.3	27.5	34.1	37.3	41.0	46.0	51.0	55.9	71.6	79.1	87.7	97.8	250					
			10.8	11.5	12.3	13.2	14.1	15.1	18.5	20.0	21.8	23.8	26.0	28.2	34.8	38.0	41.8	46.7	51.7	56.7	72.5	79.9	88.6	98.6	280					
				12.2	13.0	13.8	14.8	15.8	19.3	20.8	22.6	24.5	26.7	28.9	35.7	38.9	42.6	47.6	52.6	57.6	73.5	80.9	89.6	99.6	315					
					13.7	14.6	15.6	16.6	20.1	21.7	23.4	25.4	27.6	29.8	36.7	39.9	43.6	48.6	53.6	58.5	74.6	82.1	90.7	100.8	355					
						15.5	16.5	17.4	21.1	22.7	24.4	26.4	28.6	30.8	37.8	41.0	44.7	49.7	54.7	59.7	75.9	83.4	92.0	102.1	400					
							17.4	18.4	22.2	23.8	25.5	27.5	29.7	31.9	39.0	42.3	46.0	51.0	55.9	60.9	77.3	84.8	93.4	103.5	450					
								19.4	23.3	24.9	26.6	28.6	30.8	33.0	40.3	43.5	47.2	52.2	57.2	62.2	78.8	86.3	94.9	104.9	500					
									24.6	26.2	27.9	29.9	32.1	34.3	41.8	45.0	48.7	53.7	58.7	63.6	80.5	88.0	96.6	106.7	560					
										27.6	29.5	31.5	33.7	35.9	43.5	46.7	50.5	55.4	60.4	65.4	82.5	90.0	98.6	108.7	630					
											31.2	33.2	35.4	37.6	45.5	48.7	52.5	57.4	62.4	67.4	84.4	92.3	100.9	111.0	710					
												35.2	37.4	39.6	47.7	51.0	54.7	59.6	64.6	69.6	87.4	94.9	103.5	113.6	800					
													39.6	41.8	50.2	53.4	57.2	62.2	67.1	72.1	90.3	97.8	106.4	116.4	900					
														44.0	52.7	55.9	59.7	64.6	69.6	74.6	93.2	100.6	109.3	119.3	1000					
															55.7	58.9	62.6	67.6	72.6	77.6	96.6	104.1	112.7	122.8	1120					
																62.2	65.9	70.9	75.8	80.8	100.3	107.8	116.4	126.5	1250					
																	69.6	74.6	79.6	84.5	104.7	112.1	120.8	130.8	1400					
																		79.6	84.5	89.5	110.4	117.9	126.5	136.6	1600					
																			89.5	94.5	116.2	123.6	132.3	142.3	1800					
																				99.4	121.9	129.4	138.0	148.1	2000					
																					128.8	136.3	144.9	155.0	2240					
																						143.8	152.4	162.4	2500					
																							161.0	171.1	2800					
																								181.5	3150					

The weights in kg/m are reference values. The weights can deviate, depending on the sheet metal thickness and the type of flange used. The flange weight is included flat-rate. The loads based on a mineral wool weight of 80 kg/m² and a thickness of 5 cm.

Weights of galvanized ventilation ducts in kg/m with (80 kg/m³, 5 cm thickness)

Sheet metal 0.75			Sheet metal 0.88						Sheet metal 1.00						Sheet metal 1.13						Sheet metal 1.25					◀ B	▶ H
200	224	250	280	315	355	400	450	500	560	630	710	800	900	1000	1120	1250	1400	1600	1800	2000	2240	2500	2800	3150			
9.1	9.6	10.2	12.1	13.0	14.0	15.2	16.4	17.7	21.0	22.9	25.1	27.6	30.4	33.2	39.8	43.8	48.3	54.3	60.4	66.4	79.4	87.8	97.6	109.0	200	200	
		10.2	13.8	13.6	14.6	15.8	17.0	18.3	21.7	23.6	25.8	28.3	31.1	33.8	40.6	44.5	49.0	55.0	61.1	67.1	80.2	88.6	98.4	109.8	224	224	
		11.4	14.5	14.3	15.3	16.4	17.7	19.0	22.4	24.3	26.5	29.0	31.8	34.5	41.3	45.3	49.8	55.8	61.9	67.9	81.0	89.5	99.2	110.6	250	250	
		15.3	15.0	16.0	17.2	18.4	19.7	23.2	25.1	27.3	29.8	32.6	35.4	42.2	46.2	50.7	56.7	62.8	68.8	74.8	82.0	90.4	100.2	111.6	280	280	
			15.9	16.9	18.1	19.3	20.6	24.2	26.1	28.3	30.8	33.6	36.3	43.3	47.2	51.8	57.8	63.8	69.9	75.9	83.1	91.6	101.3	112.7	315	315	
				17.9	19.1	20.3	21.6	25.3	27.2	29.4	31.9	34.7	37.4	44.5	48.4	53.0	59.0	65.0	71.1	77.1	84.4	92.9	102.6	114.0	355	355	
					20.2	21.5	22.7	26.5	28.5	30.7	33.2	35.9	38.7	45.9	49.8	54.3	60.4	66.4	72.4	78.4	85.9	94.3	104.1	115.5	400	400	
						22.7	24.0	27.9	29.8	32.0	34.5	37.3	40.1	47.4	51.3	55.8	61.9	67.9	73.9	79.9	87.5	96.0	105.7	117.1	450	450	
							25.3	29.3	31.2	33.4	35.9	38.7	41.4	48.9	52.8	57.3	63.4	69.4	75.4	81.4	89.1	97.6	107.4	118.7	500	500	
								30.9	32.9	35.1	37.6	40.3	43.1	50.7	54.6	59.1	65.2	71.2	77.3	83.3	91.1	99.5	109.3	120.7	560	560	
									34.8	37.0	39.5	42.3	45.0	52.8	56.7	61.3	67.3	73.3	79.4	85.4	93.4	101.8	111.6	123.0	630	630	
										39.2	41.7	44.5	47.2	55.2	59.1	63.7	69.7	75.7	81.8	87.8	96.0	104.4	114.2	125.6	710	710	
											44.2	47.0	49.7	57.9	61.9	66.4	72.4	78.5	84.5	90.5	98.9	107.4	117.1	128.5	800	800	
												49.7	52.5	61.0	64.9	69.4	75.4	81.5	87.5	93.5	102.1	110.6	120.4	131.8	900	900	
													55.3	64.0	67.9	72.4	78.5	84.5	90.5	96.5	105.4	113.9	123.6	135.0	1000	1000	
														67.6	71.5	76.0	82.1	88.1	94.1	100.1	109.3	117.8	127.5	138.9	1120	1120	
															75.4	80.0	86.0	92.0	98.1	104.1	113.5	122.0	131.8	143.1	1250	1250	
																84.5	90.5	96.6	102.6	108.6	118.4	126.9	136.6	148.0	1400	1400	
																	96.6	102.6	108.6	114.7	124.9	133.4	143.1	154.5	1600	1600	
																		108.6	114.7	120.7	131.4	139.9	149.6	161.0	1800	1800	
																			120.7	126.7	137.9	146.4	156.2	167.5	2000	2000	
																				145.7	154.2	164.0	175.3	2240	2240		
																					162.7	172.4	183.8	200.0	2500	2500	
																						182.2	193.6	210.0	2800	2800	
																							204.9	222.0	3150	3150	

Important dimensions, variables and units

Material

S 250 GD

	Material No.	Tensile strength Rm N/mm ² min.	Yield strength ReH N/mm ² min.	Elongation at break A80% min.
S 250 GD	1.0242	≥ 330	≥ 250	≥ 19

DX 51 D

DX 51 D	1.0226	270 - 500	- *	≥ 22
---------	--------	-----------	-----	------

*For fischer profiles defined 240 N/mm²

DC 01

DC 01	1.0330	270 - 410	≤ 280	≥ 28
-------	--------	-----------	-------	------

S 235 JR

S 235 JR	1.0037	360 - 510	≥ 235	19/17
----------	--------	-----------	-------	-------

DD 11

DD 11	1.0332	440	170 - 360	LO = 80mm 23	24	LO = 5,65√S0 28
-------	--------	-----	-----------	-----------------	----	--------------------

equivalents of carbon steel qualities

DIN EN ISO		ASTM	
Description	Material-no.		
S 250 GD+Z	1.0242	DIN EN 10346	A 569
DD11	1.0332	DIN EN 10111	A 569
DC01	1.0330	DIN EN 10130	A 366
St 22	1.0320	DIN 1614-1	n/a
DX51D+Z 275 NA-C	1.0226+Z	DIN EN 10327	A 653
S235JR	1.0037	DIN EN 10025	A 283
S 355 MC	1.0976	DIN EN 10149	Gr. 50
4.6; 4.8, 5.8, 8.8	DIN EN ISO 898-1		F 568M

Design Curve 1

Channels capacity under **concentrated load** (deflection is limited to $L / 200$).

The required partial safety factors for material resistance as well as a partial safety factor for load actions of $\gamma = 1,4$ are considered.

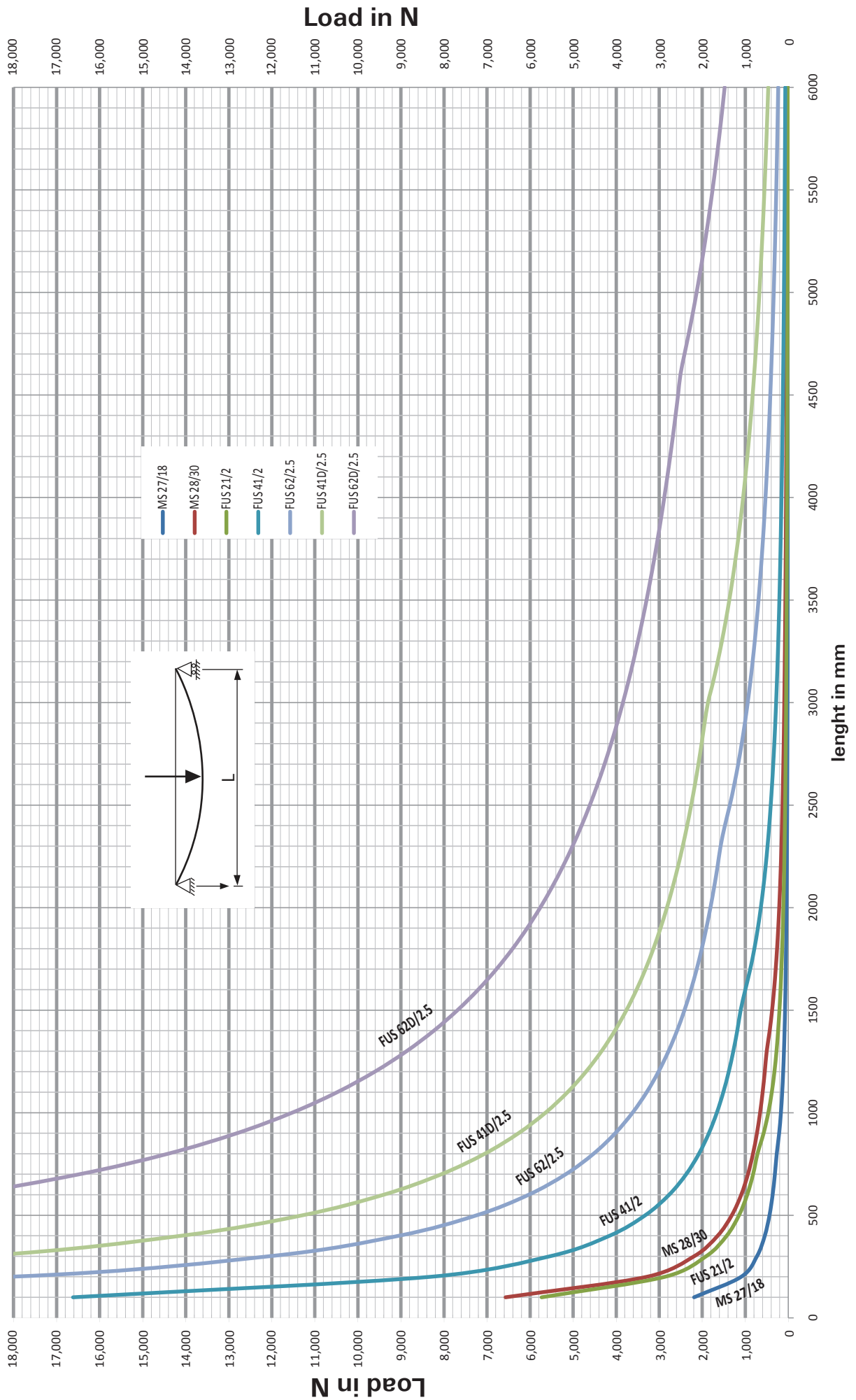

Design Curve 2

Channels capacity under **uniform distributed load** (deflection is limited to $L / 200$).

The required partial safety factors for material resistance as well as a partial safety factor for load actions of $L = 1,4$ are considered.

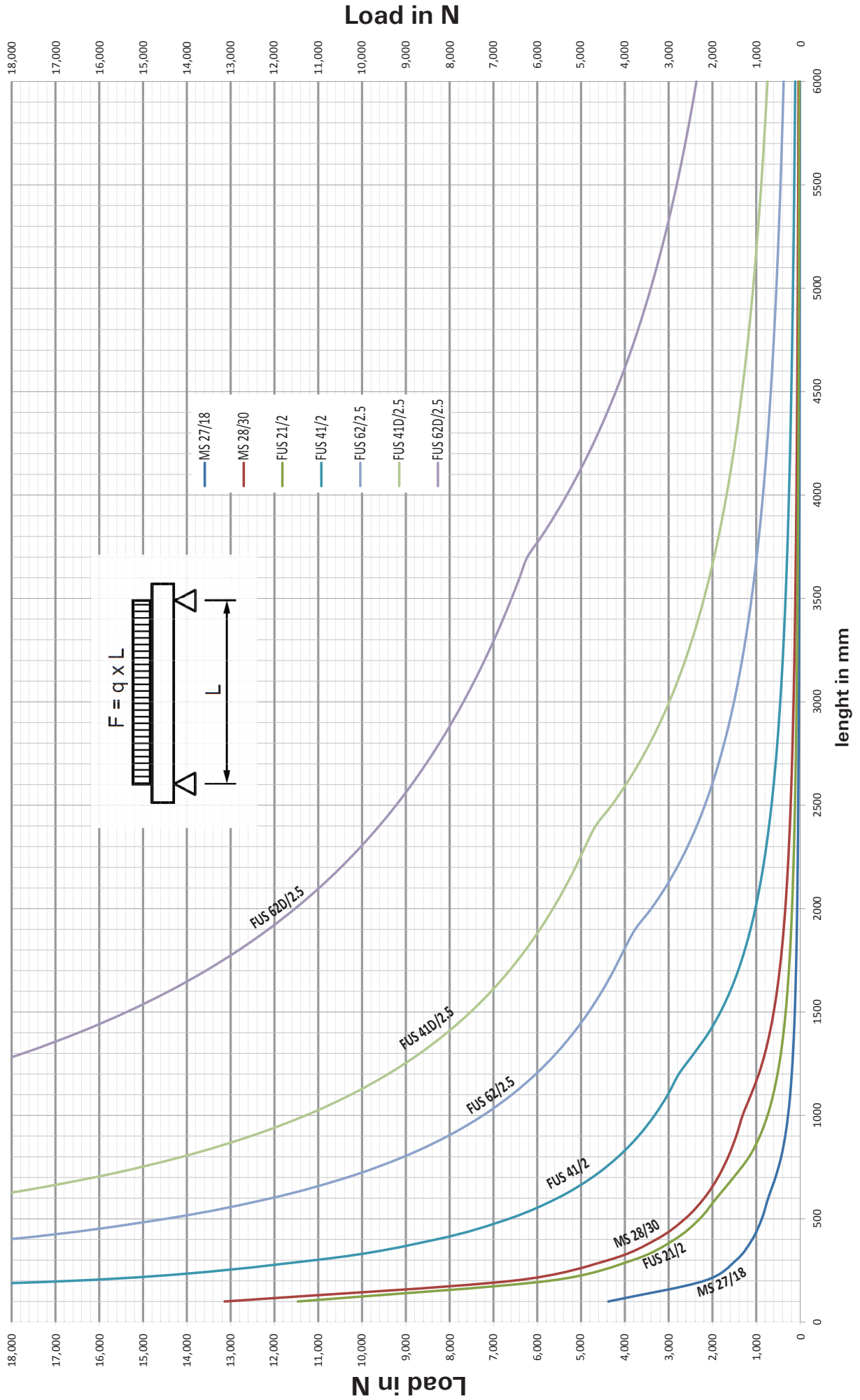

Suspended Supports

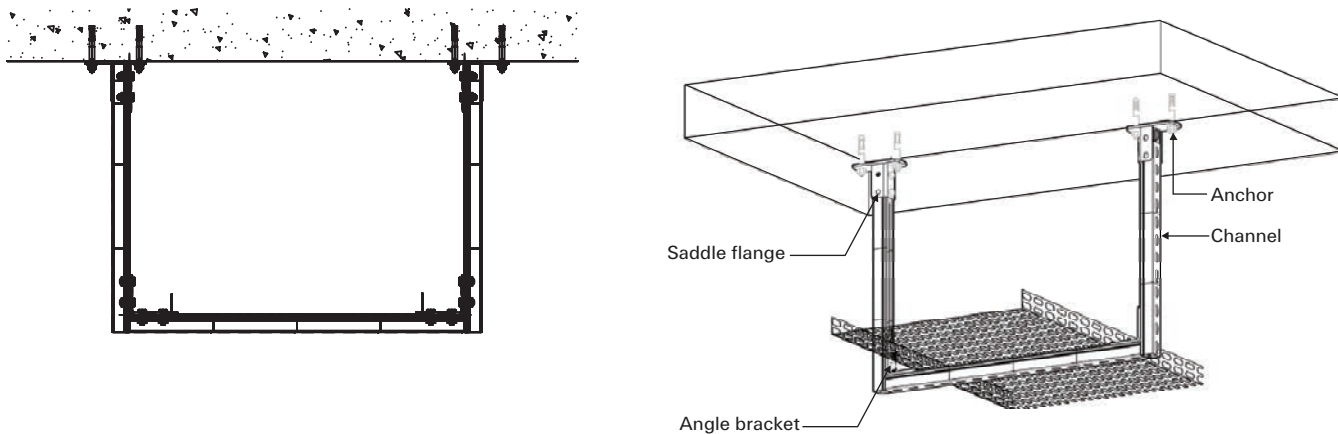
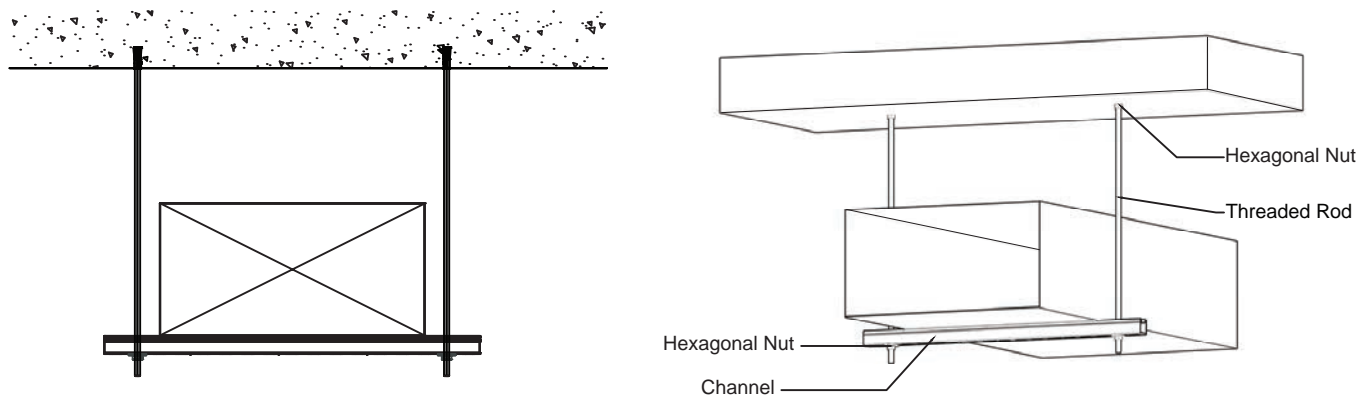
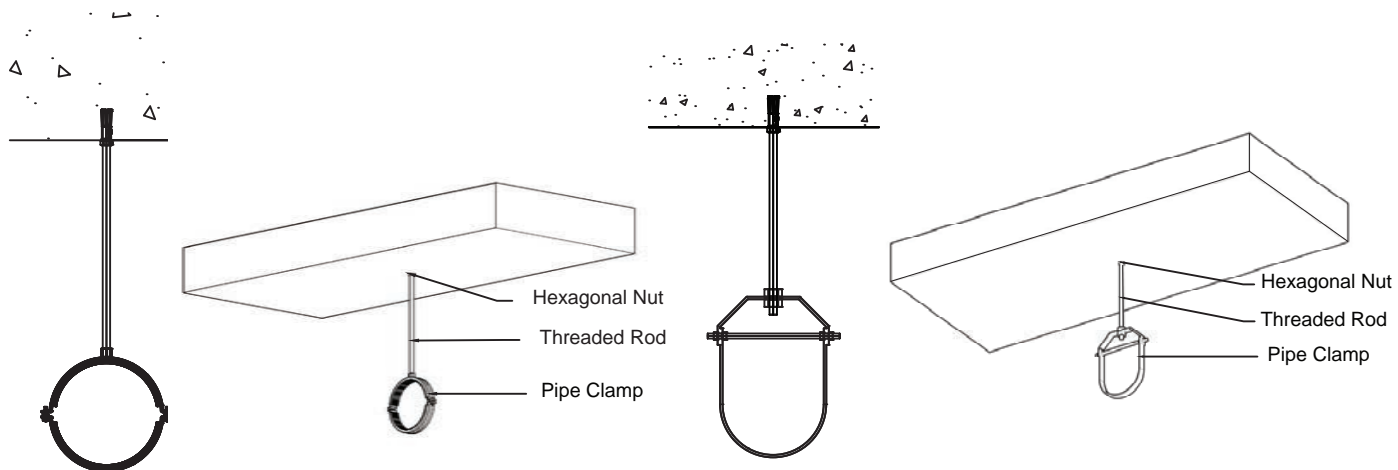

Floor Mounted Supports

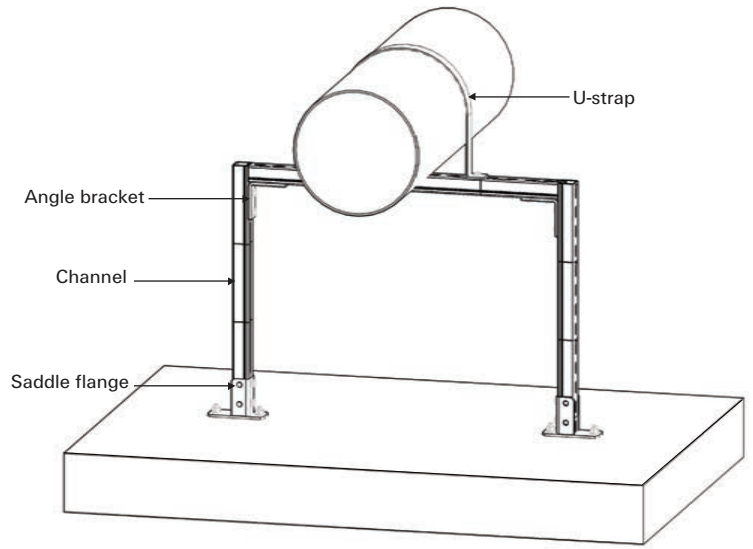
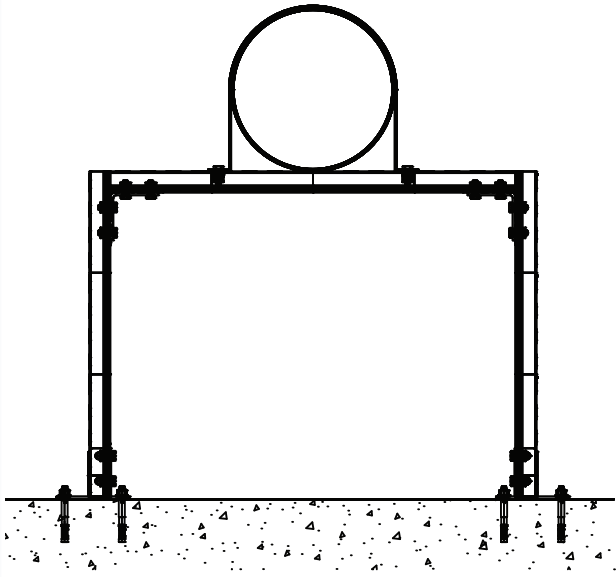

Suspended Supports

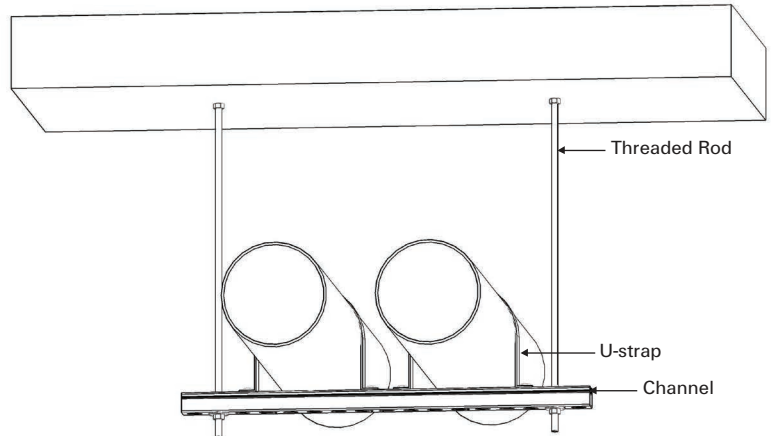
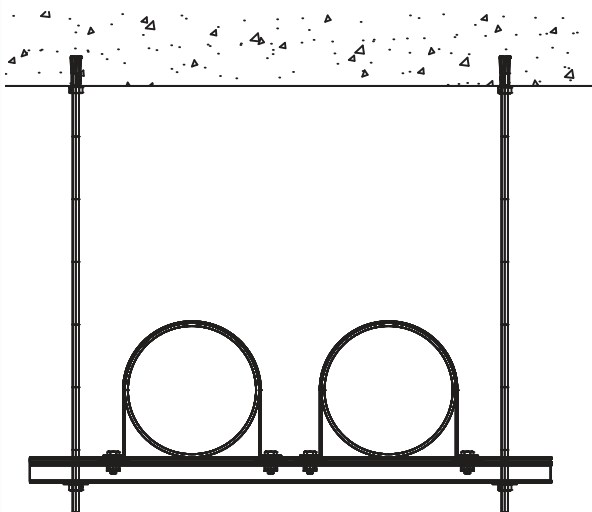
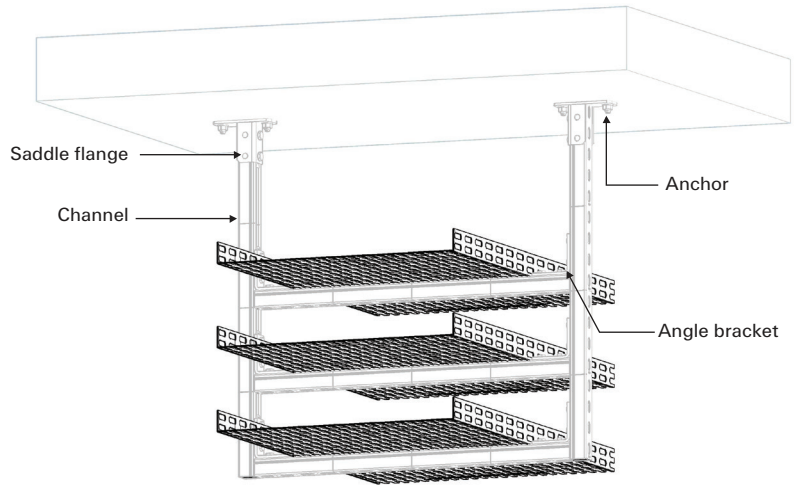
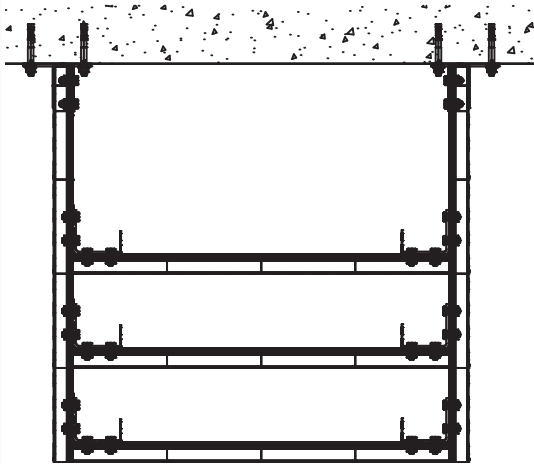

Cantilever Supports

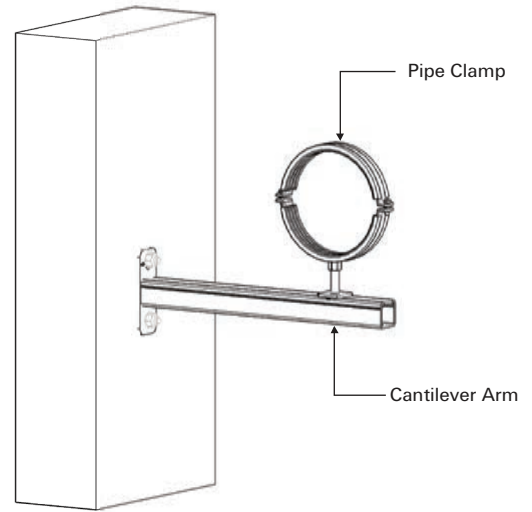
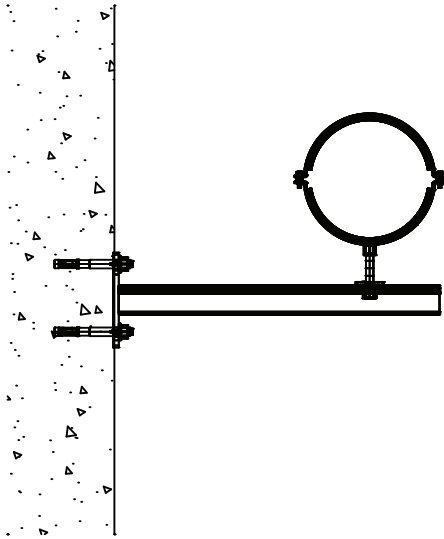

Cantilever Support with Bracing

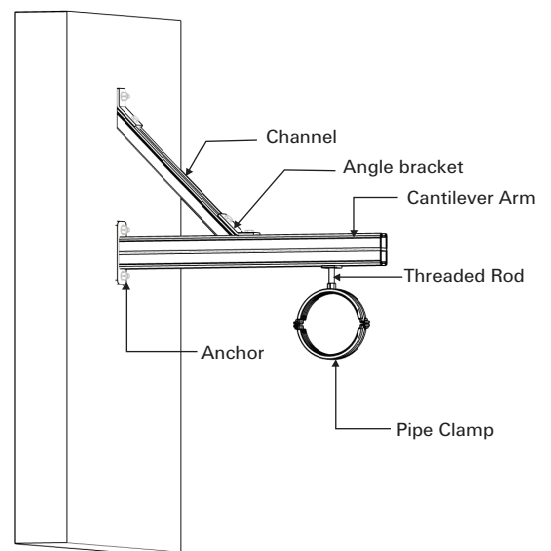
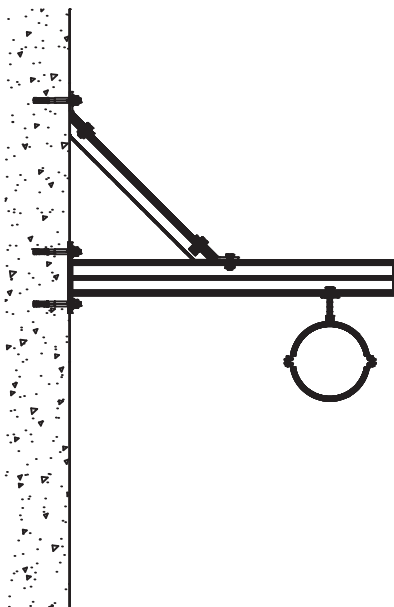
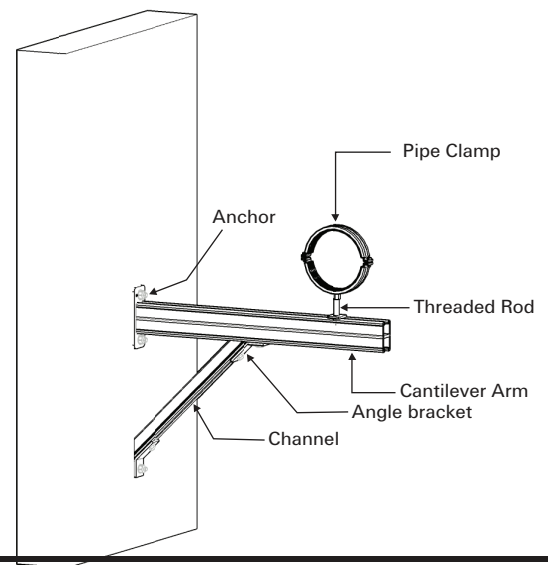
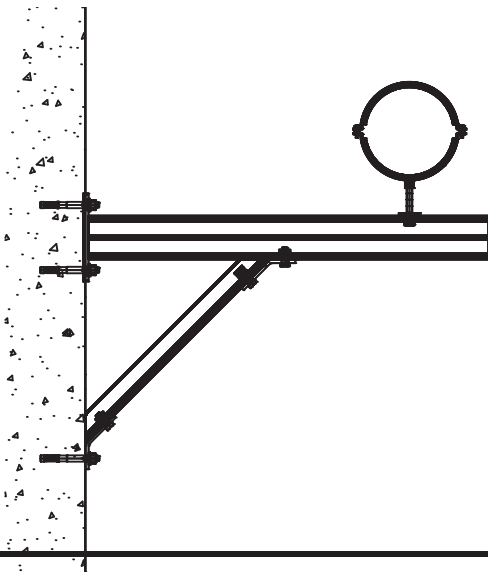

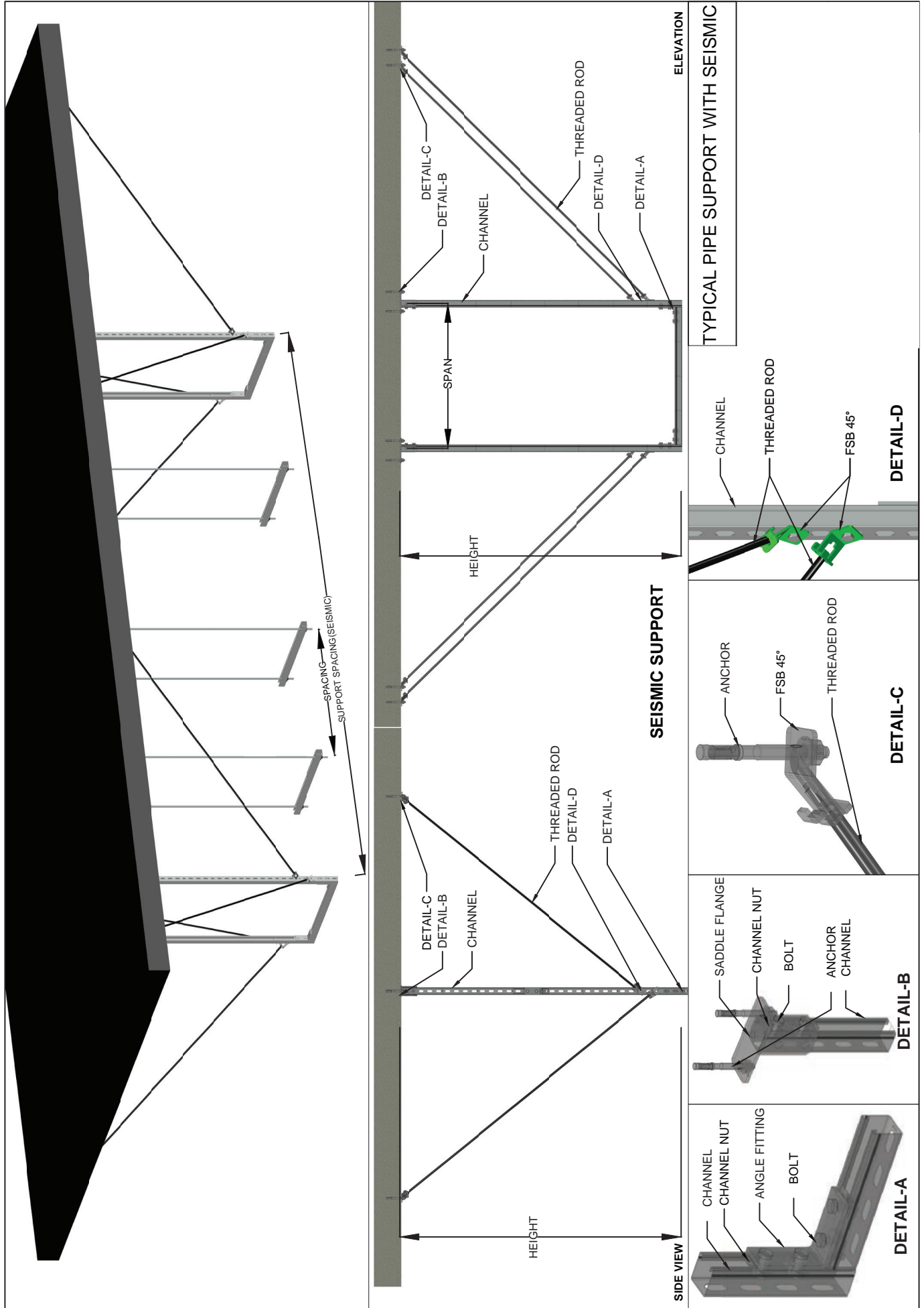

fischer International Subsidiaries

-  **fischer Deutschland Vertriebs GmbH**
Weinhalde 14-18
72178 Waldachtal
GERMANY
Tel.: (0049) 744312-6000
Fax: (0049) 744312-4500
www.fischer.de
E-Mail: info@fischer.de
anwendungstechnik@fischer.de
vertriebsnendienst@fischer.de
-  **fischer Cobemabel s.n.c.**
Schaliënhoevredreef 20 D
2800 Mechelen
BELGIUM
Tel.: (0032) 152847-00
Fax: (0032) 152847-10
www.fischer.be
E-Mail: info@fischerbelgium.be
-  **fischer international s.r.o.**
Průmyslová 1833
25001 Brandýs nad Labem
CZECH REPUBLIC
Tel.: +(00420) 3269046-01
Fax: (00420) 3269046-00
www.fischer.cz
E-Mail: info@fischerwerke.cz
-  **fischer S.A.S.**
12, rue Livio B. P. 10182
67022 Strasbourg-Cedex
FRANCE
Tel.: (0033) 38839-1867
Fax: (0033) 38839-8044
www.fischer.fr
E-Mail: info@fischer.fr
-  **fischer Argentina S.A.**
Armenia 3044
1605 Munro
Ra-PCIA: De Buenos Aires
ARGENTINA
Tel.: (0054) 1147-622778
Fax: (0054) 1147-561311
www.fischer.com.ar
E-Mail: asistenciatecnica@fischer.com.ar
-  **fischer Brasil Indústria e Comércio Ltda.**
Estrada do Dende, 300 Ilha do Governador
BR-21920-001 Rio de Janeiro-RJ
BRAZIL
Tel.: (0055) 21 24 67 87 96
Fax: (0055) 21 24 67 11 30
www.fischerbrasil.com.br
E-Mail: fischer@fischerbrasil.com.br
-  **fischer a/s**
Sandvadsvej 17 A
4600 Kage
DENMARK
Tel.: (0045) 4632-0220
Fax: (0045) 4632-5052
www.fischerdanmark.dk
E-Mail: fidk@fischerdanmark.dk
-  **fischer fixings UK Limited**
Whitley Road
Oxon OX10 9AT Wallingford
OX 10 9AT
GREAT BRITAIN
Tel.: (0044) 149 182 79-00
Fax: (0004) 149 182 79-53
www.fischer.co.uk
E-Mail: info@fischer.co.uk
-  **fischer Australia Pty. Ltd.**
Unit 1, 61 Waterview Close
Dandenong South
VIC 3175
AUSTRALIA
Tel.: (0061) 39799-2096
Fax: (0061) 39799-2696
www.fischerfixings.com.au
E-Mail: info@fischerfixings.com.au
-  **fischer (Taicang) fixings Co., Ltd.**
Shanghai Rep. Office
Rm 1503-1504,
No. 63 Chifeng Road,
200092 Shanghai
CHINA
Tel.: (0086) 2151001668
Fax: (0086) 2165979669
www.fischer.com.cn
E-Mail: ficnsh@fischer.com.cn
-  **fischer Finland**
Suomalaistentie 7 B
02270 Espoo
FINLAND
Tel.: (00358) 2074146-60
Fax: (00358) 2074146-69
www.fischer.de
E-Mail: jorma.makkonen@fischerfinland.fi
-  **fischer Hellas**
Emporiki EPE G, Papandreou 125
144 52 Metamorphosis, Athens
GREECE
www.fischer.gr
-  **fischer Austria GmbH**
Wiener Straße 95
2514 Traiskirchen
AUSTRIA
Tel.: (0043) 225253730
Fax: (0043) 225253730-70
www.fischer.at
E-Mail: office@fischer.at
-  **fischer Hrvatska d.o.o.**
Nadinska 29 - Velikopojje
10010 Zagreb
CROATIA
www.fischer.ar
E-Mail: alen.dopsaj@fischer.at
-  **fischer systems Asia Pte. Ltd.**
150 Kampong Ampat
#04-03 KA Centre
Singapore 368324
SINGAPORE
Tel.: (0065) 6285-2207
Fax: (0065) 6285-8310
www.fischer.sg
E-Mail: sales@fischer.sg
-  **fischer HUNGÁRIA Bt.**
Szerémi út 7.
1117 Budapest
HUNGARY
Tel.: (0036) 134797-55
Fax: (0036) 134797-66
www.fischerhungary.hu
E-Mail: info@fischerhungary.hu
-  **fischer italia s.r.l.**
Corso Stati Uniti, 25
Casella Postale 391
35127 Padova Z.I. Sud
ITALY
Tel.: (0039) 0498063-111
Fax: (0039) 0498063-401
www.fischeritalia.it
E-Mail: sercli@fischeritalia.it
-  **fischer Norge AS**
Oluf Onsumsvei 9
0680 OSLO
NORWAY
Tel.: (0047) 232427-10
Fax: (0047) 232427-13
www.fischernorge.no
E-Mail: jmo@fischernorge.no
-  **fischer S. K. s. r. o.**
Vajnorská 134/A
831 04 Bratislava
SLOVAKIA
Tel.: (0421) 2 4920 6046
Fax: (0421) 2 4920 6044
E-Mail: info@fischerwerke.sk
www.fischer-sk.sk
-  **fischer Japan K.K.**
Seishin Kudan Building 3rd Floor
3-4-15 Kudan Minami
Chiyoda-ku
Tokyo 102-0074
JAPAN
Tel.: (0081) 503675-7782
Fax: (0081) 503675-7782
www.fischerjapan.co.jp
E-Mail: georg.lenz@fischerjapan.co.jp
-  **fischerpolska Sp. z o.o.**
ul. Albatrosow 2
30-716 Kraków
POLAND
Tel.: (0048) 1229008-80
Fax: (0048) 1229008-88
www.fischerpolska.pl
E-Mail: info@fischerpolska.pl
-  **fischer Korea Co. Ltd.**
#503 Dae-Pyung Techno Town 8th 481-11
Gasan-dong, Geumcheon-Gu
153-775 SEOUL
SOUTH KOREA
Tel.: (0082) 154489-55
Fax: (0082) 154489-03
www.fischerkorea.com
E-Mail: info@fischerkorea.com
-  **fischer Sverige AB**
Koppargatan 11
602 23 Norrköping
SWEDEN
Tel.: (0046) 1131-4450
Fax: (0046) 1131-1950
www.fischersverige.se
E-Mail: gg@fischersverige.se
-  **fischer Sistemas de Fijación, S.A. de C.V.**
Blvd. Manuel Avila Camacho 3130 - 400B
Col. Valle Dorado, Tlalnepantla
Estado de Mexico, C.P. 54020
MEXICO
Tel.: (0052) 555572-0883
Fax: (0052) 555572-1590
www.fischer.de
E-Mail: info@fischermex.mx
-  **fischerwerke Portugal, Lda**
Av. Casal da Serra, Lote 1-4, Sala 5
2625-085 Povoia de Santa Iria
PORTUGAL
Tel.: (00351) 2195-37450
Fax: (00351) 2195-91390
www.fischer.pt
E-Mail: fischerportugal.info@fischer.es
-  **Fischer Ibérica S.A.**
Klaus Iberer 1
43300 Mont-Roig del Camp
Tarragona
SPAIN
Tel.: (0034) 9778387-11
Fax: (0034) 9778387-70
www.fischer.es
E-Mail: tacos@fischer.es
-  **fischer Building Material India PV. LTD.**
Prestige Granet,
36, Ulsoor Road, 4th Floor
Bangaluru Karnataka-560042
INDIA
Tel.: (0091) 8041511991/92/93
Fax: (0091) 8041511989
www.fischer.de
E-Mail: info@fischer.in
-  **fischer Benelux B.V.**
Amsterdamsestraatweg 45 B/C
1411 AX Naarden
NETHERLANDS
Tel.: (0031) 3569566-66
Fax: (0031) 3569566-99
www.fischer.nl
E-Mail: info@fischer.nl
-  **000 fischer Befestigungssysteme Rus**
I. Dokukina 16/1, Building 1
129226 Moscow
RUSSIA
Tel.: (007) 495 223-0334
Fax: (007) 495 223-0334
www.fischerfixings.ru
E-Mail: info@fischerfixings.ru
-  **fischer fixings LLC**
62 Orange Ave
Suffern, NY 10901
USA
Tel.: (001) 845-5045098
Fax: (001) 845-6252666
www.fischerfixings.com
E-Mail: info@fischerfixingsusa.com
-  **fischer PH Asia, Inc.**
No 100 Congressional Avenue,
Project 8, 1106 Quezon City
Philippines
Tel.: (0063) 2426/0888217
E-Mail: emanuel.lopez@fischerph.com

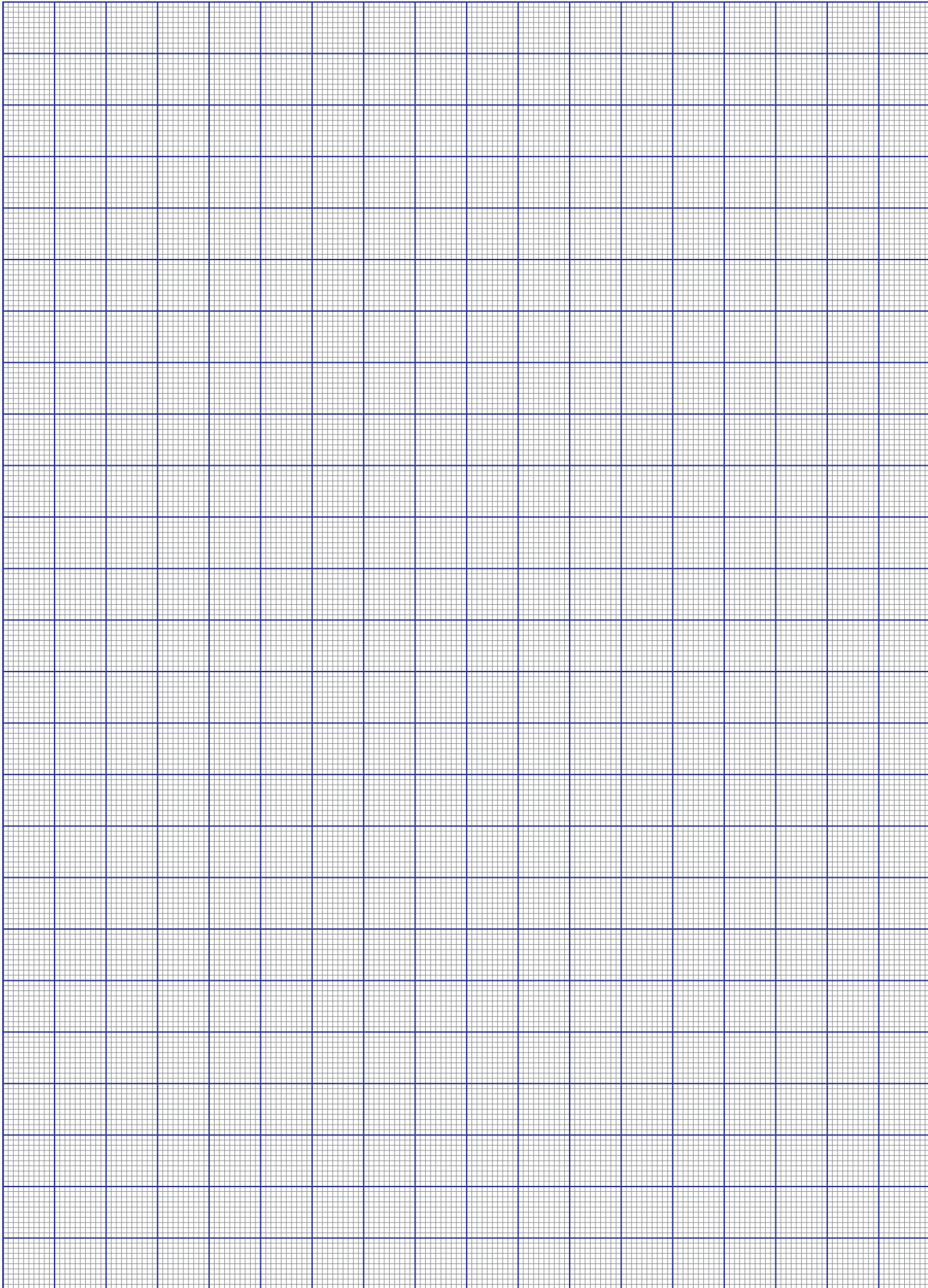

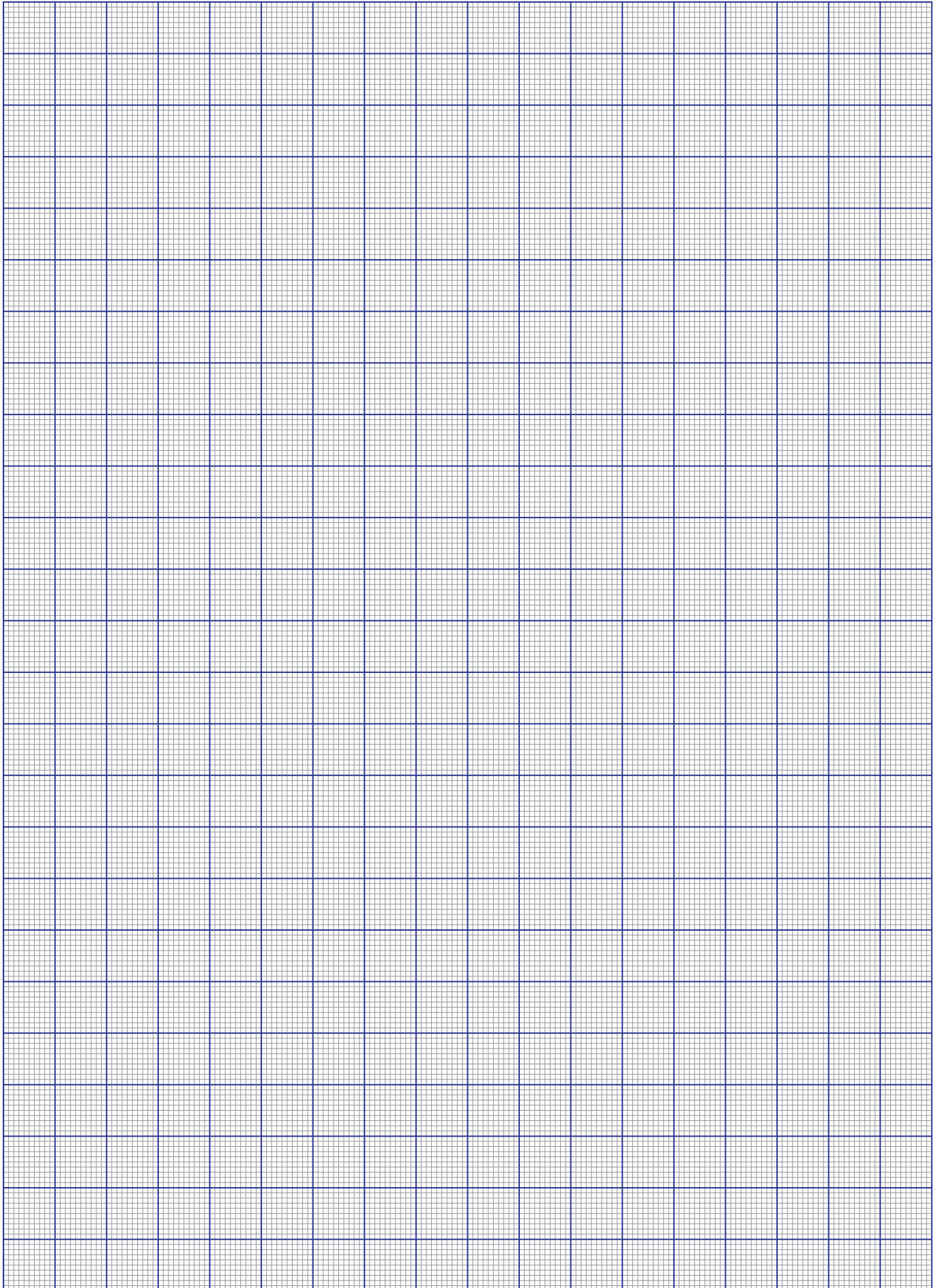

HIGHLY COMMENDED
MEP SUPPLIER OF THE YEAR 2016

10th MEP
ANNUAL AWARDS 2016



The information in this catalogue is intended for general guidance only and is given without engagement. Additional information and advice on specific applications is available from our Technical Support Team. For this however, we require a precise description of your particular application.

All the data in this catalogue concerning work with our fixing elements must be adapted to suit local conditions and the type of materials in use. If no detailed performance specifications are given for certain articles and types, please contact our Technical Service Department for advice.

fischer FZE (Regional Office)

R/A 07, BA 01 - 04
Jebel Ali Free Zone
Dubai, UAE
P. O. Box 261738
Tel: +971 4 883 7477
Fax: +971 4 883 7476
Email: enquiry@fischer.ae

We cannot be responsible for any errors, and we reserve the right to make technical and range modifications without notice. No liability is accepted for printing errors and omissions.

Global Presence

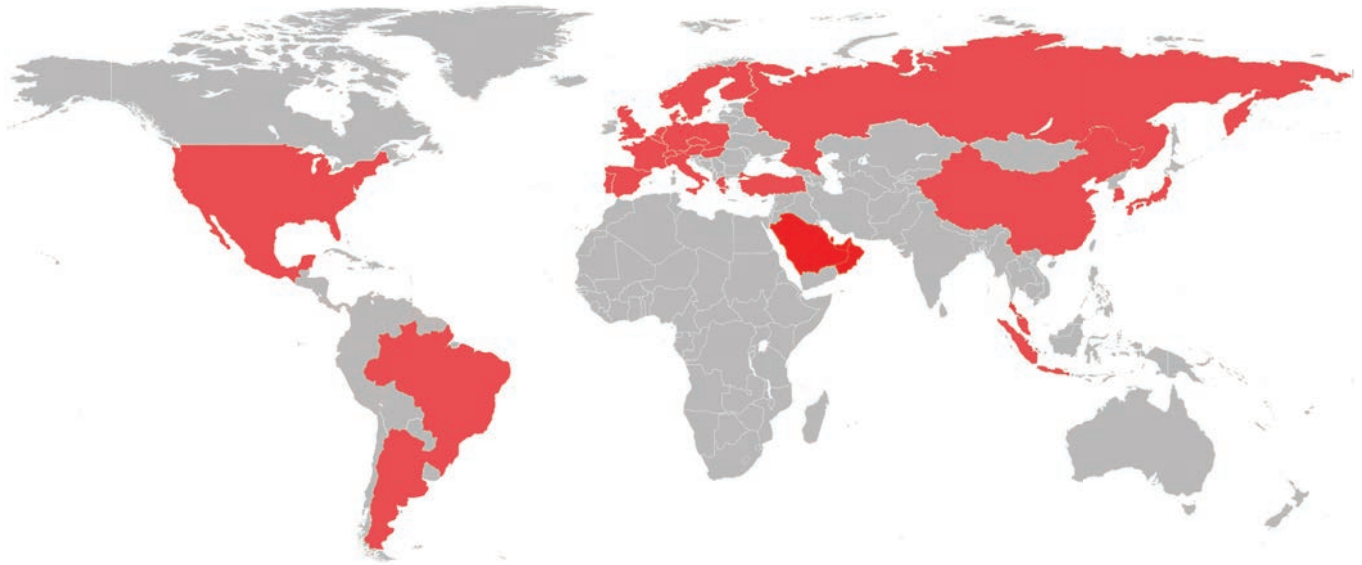

Regional Presence

U.A.E

fischer FZE (Regional Office)
R/A 07, BA 01 - 04
Jebel Ali Free Zone
Dubai, UAE
P. O. Box 261738
Tel: +971 4 883 7477
Fax: +971 4 883 7476
Email: enquiry@fischer.ae

fischer Fixing LLC
426, Al Fahim HQ Building
Mercedes Service Center Building
Mussafah, Abu Dhabi
Tel: +971 2 552 5777
Fax: +971 2 552 6566
Email: enquiry@fischer.ae

State of Qatar

Tel: +974 4036 3100
Fax: +974 4471 0898
Email: qatar@fischer.ae

Kingdom of Bahrain

Tel: +973 17408090
Fax: +973 17404323
Email: bahrain@fischer.ae

Kingdom of Saudi Arabia

Tel: +966 13 8140866
Fax: +966 13 8140855
Email: saudi@fischer.ae

State of Kuwait

Tel: +965 2481 8786,
+965 2482 5972
Fax: +965 2481 8385
Email: kuwait@fischer.ae

Sultanate of Oman

Tel: +968 24445425/26/27/28/30
Fax: +968 24445423
Email: oman@fischer.ae

Pakistan

Tel: +923 01 8266216
Email: pakistan@fischer.ae

Follow us:



www.fischer.ae

FCN Clix P



FCN Clix M

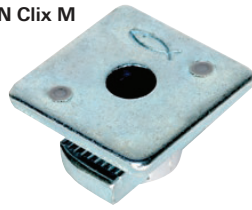

FCN



FCN-L



PROPERTIES

- **Material 1:** Steel S235 JR (material no. 1.0037) acc. DIN EN 10025, plastic nylon PA6
- **Zinc plating:** Electro zinc plated, min. 5 µm
- **Material 2 HDG:** Steel S235 JR (material no. 1.0037) acc. to DIN EN 10025
- **Zinc plating HDG:** Hot-dip galvanized, approx 40 µm acc. to DIN EN ISO 1461
- **Material A4:** Stainless steel of the corrosion resistance class III, e.g. A4
- **Plastic:** Nylon PA 6
- **Material:** ISO 898-1, DIN 975 & 976 (Steel: 4.8 & 8.8)
- **Finish FCN-L:** Electro galvanized (as per ASTM B633), Electro Galvanized (as per ASTM B633),
- **Material SS316:** DIN EN ISO 3506-1

TECHNICAL DATA

FCN

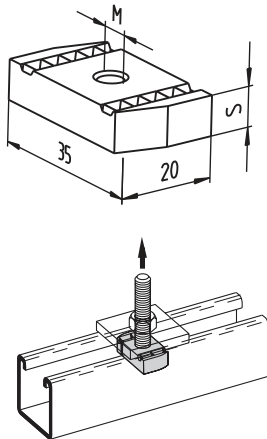

Spring nut tensile resistance

FCN Clix P

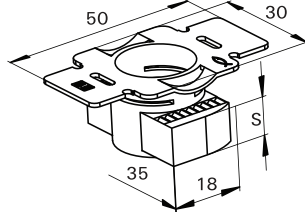

FCN Clix M

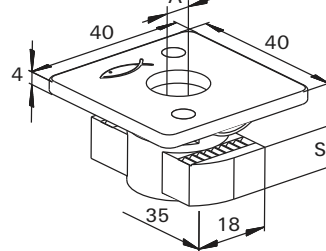

Spring nut shear resistance

Item	Art.-NO.	Qty. per box (pcs.)	Thread M	Thickness S (mm)	Max. tension load for FUS 2.0 mm		Max. tension load for FUS 2.5 mm		Max. shear load		Tightening torque for screw grade ≥ 8.8 Tinst (kN)
					Nrec (kN)	Ndesign (kN)	Nrec (kN)	Ndesign (kN)	Vrec (kN)	Vdesign (kN)	
FCN Clix P 6	504326	100	M 6	6	3.0	4.2	3.0	4.2	1.0	1.4	10
FCN Clix P 8	504327	100	M 8	6	4.0	5.6	4.0	5.6	2.0	2.8	20
FCN Clix P 10	504329	100	M 10	8	5.0	7.0	8.0	11.2	2.5	3.5	40
FCN Clix P 12	504331	100	M 12	9.5	5.0	7.0	8.0	11.2	3.0	4.2	50
FCN Clix M 6	504344	100	M 6	6	3.0	4.2	3.0	4.2	1.0	1.4	10
FCN Clix M 8	504345	100	M 8	6	4.0	5.6	4.0	5.6	2.0	2.8	20
FCN Clix M 10	504346	100	M 10	8	5.0	7.0	8.0	11.2	2.5	3.5	40
FCN Clix M 12	504347	100	M 12	9.5	5.0	7.0	8.0	11.2	3.0	4.2	50
FCN Clix P 12 HDG	517420	100	M 12	9.5	5.0	7.0	8.0	11.2	1.5	2.1	50
FCN Clix P 8 A4	504436	100	M 8	6	4.0	5.6	4.0	5.6	2.0	2.8	20
FCN Clix P 10 A4	504437	100	M 10	8	5.0	7.0	8.0	11.2	2.5	3.5	40
FCN Clix P 12 A4	504439	100	M 12	9.5	5.0	7.0	8.0	11.2	3.0	4.2	50
FCN Clix M 8 A4	504440	100	M 8	6	4.0	5.6	4.0	5.6	2.0	2.8	20
FCN Clix M 10 A4	504447	100	M 10	8	5.0	7.0	8.0	11.2	2.5	3.5	40
FCN 6	77405	100	M 6	6	3.0	4.2	3.0	4.2	1.0	1.4	10
FCN 8	77407	100	M 8	6	4.0	5.6	4.0	5.6	2.0	2.8	20
FCN 10	77409	100	M 10	8	5.0	7.0	8.0	11.2	2.5	3.5	40
FCN 12	77411	100	M 12	9	5.0	7.0	8.0	11.2	2.5	3.5	50

Item	Art.-NO. GI	Art.-NO. HDG	Art.-NO. SS316	Spring length (mm)	Thread D	Max. tension load for FUS 2.0 mm		Max. tension load for FUS 2.5 mm		Max. shear load		Tightening torque for screw grade ≥ 8.8 Tinst (kN)
						Nrec (kN)	Ndesign (kN)	Nrec (kN)	Ndesign (kN)	Vrec (kN)	Vdesign (kN)	
FCN-L6	516750	516765	516774	6	M 6	3.0	4.2	3.0	4.2	1.0	1.4	10
FCN-L8	516751	516766	516775	6	M 8	4.0	5.6	4.0	5.6	2.0	2.8	20
FCN-L10	516752	516767	516776	8	M 10	5.0	7.0	8.0	11.2	2.5	3.5	40
FCN-L12	516753	516768	-	9	M 12	5.0	7.0	8.0	11.2	2.5	3.5	50
FCN-L12	-	-	516777	9.2	M 12	5.0	7.0	8.0	11.2	2.5	3.5	50
FCN-L12	-	516769	-	12	M 12	5.0	7.0	8.0	11.2	2.5	3.5	50